

Optidrive Plus 3^{GV}

IP20 & Enclosed IP55 / NEMA 12

AC Variable Speed Drive

0.37 – 160kW (0.5 – 250HP)



OPTIDRIVE
EASY
START • UP
SEE BACK PAGE

Installation and operating instructions

Declaration of Conformity:

Invertek Drives Ltd hereby states that the Optidrive Plus 3^{GV} product range is CE marked for the low voltage directive and conforms to the following harmonised European directives:

EN 61800-5-1: 2003	Adjustable speed electrical power drive systems. Safety requirements. Electrical, thermal and energy.
EN 61800-3 2 nd Ed: 2004	Adjustable speed electrical power drive systems. EMC requirements and specific test methods
EN 55011: 2007	Limits and Methods of measurement of radio disturbance characteristics of industrial, scientific and medical (ISM) radio-frequency equipment (EMC)
EN60529 : 1992	Specifications for degrees of protection provided by enclosures

CE - Konformitätserklärung:

gemäß den Produktnormen für Drehzahlveränderbare Antriebe, die Firma 'Invertek Drives Ltd., UK erklärt dass das Produkt: Optidrive Plus/VTC (statischer Frequenzumrichter zur Drehzahlregelung von Asynchronmotoren) nach den folgenden harmonisierten Produktnormen entwickelt und gebaut wird:

EN 61800-5-1: 2003	Elektrische Leistungsantriebssysteme mit einstellbarer Drehzahl. Anforderungen an die Sicherheit. Elektrische, thermische und energetische Anforderungen
EN 61800-3 2 nd Ed: 2004	Drehzahlveraenderbare elektrische Antriebe. EMV-Anforderungen einschliesslich spezieller Prueverfahren
EN 55011: 2007	Industrielle, wissenschaftliche und medizinische Hockfrequenzgeraeten (ISM-Geraeten). Funkstoerungen. Grenzwerte und Messverfahren
EN60529 : 1992	Schutzarten durch Gehaeuse (IP Code)

Déclaration de Conformité:

Invertek Drives Ltd déclare par la présente que le produit Optidrive Plus/VTC porte le marquage CE en relation avec la directive basse tension et est conforme aux normes Européennes harmonisées suivantes :

EN 61800-5-1: 2003	Entrainements électriques de puissance à vitesse variable. Exigences de sécurité. Electrique, thermique et énergétique
EN 61800-3 2 nd Ed: 2004	Entrainements électriques de puissance à vitesse variable. Exigences de CEM et méthodes d'essais spécifiques
EN 55011: 2007	Appareils industriels, scientifiques et médicaux (ISM) à fréquence radioélectrique. Caractéristiques de perturbations radioélectriques. Limites et méthodes de mesure
EN60529 : 1992	Degrés de protection procures par les enveloppes (Code IP)

All rights reserved. No part of this User Guide may be reproduced or transmitted in any form or by any means, electrical or mechanical including photocopying, recording or by any information storage or retrieval system without permission in writing from the publisher.

Copyright Invertek Drives Ltd © 2007

All Invertek Optidrive Plus 3^{GV} units carry a 2 year warranty against manufacturing defects from the date of manufacture. The manufacturer accepts no liability for any damage caused during or resulting from transport, receipt of delivery, installation or commissioning. The manufacturer also accepts no liability for damage or consequences resulting from inappropriate, negligent or incorrect installation, incorrect adjustment of the operating parameters of the drive, incorrect matching of the drive to the motor, incorrect installation, unacceptable dust, moisture, corrosive substances, excessive vibration or ambient temperatures outside of the design specification.

The local distributor may offer different terms and conditions at their discretion, and in all cases concerning warranty, the local distributor should be contacted first.

The contents of this User Guide are believed to be correct at the time of printing. In the interest of a commitment to a policy of continuous improvement, the manufacturer reserves the right to change the specification of the product or its performance or the contents of the User Guide without notice.

This User Guide is for use with V3.xx Firmware.

User Guide Issue 3.00 11/08

Invertek Drives Ltd adopts a policy of continuous improvement and whilst every effort has been made to provide accurate and up to date information, the information contained in this User Guide should be used for guidance purposes only and does not form the part of any contract.

1.	INTRODUCTION	4
1.1.	Important safety information	4
1.2.	Electromagnetic Compatibility (EMC)	4
2.	GENERAL INFORMATION AND RATINGS.....	5
2.1.	Drive model numbers	5
3.	MECHANICAL INSTALLATION	6
3.1.	Mechanical dimensions and mounting	6
3.2.	General.....	8
3.3.	Enclosure mounting	8
4.	POWER AND CONTROL CONNECTIONS	9
4.1.	Grounding the Drive.....	9
4.2.	Wiring Precautions.....	9
4.3.	Connection Diagram	10
4.4.	Drive and motor connections	10
4.5.	Motor Terminal Box Connections	10
4.6.	Control terminal connections	11
5.	OPERATION	12
5.1.	Managing the keypad.....	12
5.2.	Changing Parameters	12
5.3.	Advanced Keypad Operation Short Cuts.....	13
5.4.	Reset All Parameters to Factory Default Settings	14
5.5.	Terminal Control	14
5.6.	Keypad Control.....	14
5.7.	Motor Autotuning	15
5.8.	Operating in Sensorless Vector Speed Control Mode.....	15
5.9.	Sensorless Vector Torque Control Mode	15
5.10.	Operation of Three Phase drives on Single Phase Supplies	15
6.	PARAMETERS	16
6.1.	Parameter Group 1 – Basic Parameters.....	16
6.2.	Parameter Group 2 - Extended parameters.....	17
6.3.	Parameter Group 3 – PID Control	20
6.4.	Parameter Group 4 – High Performance Motor Control	20
6.5.	Parameter Group 0 – Monitoring Parameters (Read Only)	21
7.	ANALOG AND DIGITAL INPUT CONFIGURATIONS	22
7.1.	Terminal mode (P1-12 =0)	22
7.2.	Keypad mode (P1-12 = 1 or 2).....	23
7.3.	User PI control mode (P1-12 = 3).....	24
7.4.	Modbus Control Mode (P1-12=4)	25
8.	TROUBLESHOOTING	26
8.1.	Fault messages	26
9.	TECHNICAL DATA.....	27
9.1.	Environmental.....	27
9.2.	Rating tables	27
9.3.	Maximum supply ratings for UL compliance:.....	30
9.4.	Recommended Maintenance.....	30
10.	MODBUS COMMUNICATIONS.....	31
10.1.	Introduction	31
10.2.	Modbus RTU Specification	31
10.3.	RJ11 Connector Configuration	31
10.4.	Modbus Telegram Structure	31
10.5.	Modbus Register Map.....	32
11.	IP55 ENCLOSED DRIVE	33
11.1.	Overview	33
11.2.	Models and Ratings.....	33
11.3.	Power and Motor Cable Installation	33
11.4.	Dimensions and Mounting	34
11.5.	Removing the Terminal Cover.....	34
11.6.	Control Terminal Wiring – None Switched Version	35
11.7.	IP55 / Nema 12K Switched Version - Wiring diagram for in-built switches	35
11.8.	Settings for typical Run / Stop switch configurations (Switched Version)	35



1. Introduction

1.1. Important safety information

This variable speed drive product (Optidrive) is intended for professional incorporation into complete equipment or systems. If installed incorrectly it may present a safety hazard. The Optidrive uses high voltages and currents, carries a high level of stored electrical energy, and is used to control mechanical plant that may cause injury. Close attention is required to system design and electrical installation to avoid hazards in either normal operation or in the event of equipment malfunction.



System design, installation, commissioning and maintenance must be carried out only by personnel who have the necessary training and experience. They must carefully read this safety information and the instructions in this Guide and follow all information regarding transport, storage, installation and use of the Optidrive, including the specified environmental limitations.

Please read the IMPORTANT SAFETY INFORMATION below, and all Warning and Caution information elsewhere.

	<p>Indicates a potentially hazardous situation which, if not avoided, could result in injury or death.</p>		<p>Indicates a potentially hazardous situation which, if not avoided, could result in damage to property.</p>
--	---	---	--

Safety of machinery, and safety-critical applications

The level of integrity offered by the Optidrive control functions – for example stop/start, forward/reverse and maximum speed, is not sufficient for use in safety-critical applications without independent channels of protection. All applications where malfunction could cause injury or loss of life must be subject to a risk assessment and further protection provided where needed. Within the European Union, all machinery in which this product is used must comply with Directive 89/392/EEC, Safety of Machinery. In particular, the electrical equipment should comply with EN60204-1.

	<p>Optidrives should be installed only by qualified electrical persons and in accordance with local and national regulations and codes of practice. The Optidrive has an Ingress Protection rating of IP20. For higher IP ratings, use a suitable enclosure.</p> <p>Electric shock hazard! Disconnect and ISOLATE the Optidrive before attempting any work on it. High voltages are present at the terminals and within the drive for up to 10 minutes after disconnection of the electrical supply.</p> <p>Where supply to the drive is through a plug and socket connector, do not disconnect until 10 minutes have elapsed after turning off the supply.</p> <p>Ensure correct earthing connections. The earth cable must be sufficient to carry the maximum supply fault current which normally will be limited by the fuses or MCB</p> <p>The STOP function does not remove potentially lethal high voltages. ISOLATE the drive and wait 10 minutes before commencing any work.</p> <p>Parameter P1-01 can be set to operate the motor at up to 120,000 rpm, hence use this parameter with care.</p> <p>If it is desired to operate the drive at any frequency/speed above the rated speed (P1-09/ P1-10) of the motor, consult the manufacturers of the motor and the driven machine about suitability for over-speed operation.</p> <p>The fan (if fitted) inside of the Optidrive starts automatically when the heatsink temperature reaches approximately 45°C.</p>
	<p>Carefully inspect the Optidrive before installation to ensure it is undamaged</p> <p>Indoor Use Only.</p> <p>Flammable material should not be placed close to the drive</p> <p>The entry of conductive or flammable foreign bodies should be prevented</p> <p>Relative humidity must be less than 95% (non-condensing).</p> <p>Ensure that the supply voltage, frequency and no. of phases (1 or 3 phase) correspond to the rating of the Optidrive as delivered.</p> <p>An isolator should be installed between the power supply and the drive.</p> <p>Never connect the mains power supply to the Output terminals U, V, W.</p> <p>Suitably rated fuses or MCB should be fitted in the mains supply to the drive.</p> <p>Do not install any type of automatic switchgear between the drive and the motor.</p> <p>Wherever control cabling is close to power cabling, maintain a minimum separation of 100 mm and arrange crossings at 90 degrees.</p> <p>Ensure that all terminals are tightened to the appropriate torque setting</p>

1.2. Electromagnetic Compatibility (EMC)

Optidrives are designed to high standards of EMC and can optionally be fitted with an internal EMC filter. This EMC filter is designed to reduce the conducted emissions back into the supply via the power cables for compliance with harmonised European standards.

It is the responsibility of the installer to ensure that the equipment or system into which the product is incorporated complies with the EMC legislation of the country of use. Within the European Union, equipment into which this product is incorporated must comply with 89/336/EEC, EMC.

All Optidrives are intended for professional installation by qualified or experienced personnel.

2. General Information and Ratings

2.1. Drive model numbers

200-240V ±10% - 1 Phase Input					
kW Model Number	kW	HP Model Number	HP	Output Current (A)	Frame Size
ODP-12037-xx	0.37	ODP-12005-USA	0.5	2.3	1
ODP-12075-xx	0.75	ODP-12010-USA	1	4.3	1
ODP-12150-xx	1.5	ODP-12020-USA	2	7	1
ODP-22150-xx	1.5	ODP-22020-USA	2	7	2
ODP-22220-xx	2.2	ODP-22030-USA	3	10.5	2

200-240V ±10% - 3 Phase Input					
kW Model Number	kW	HP Model Number	HP	Output Current (A)	Frame Size
ODP3-22150-xx	1.5	ODP3-22020-USA	2	7	2
ODP3-22220-xx	2.2	ODP3-22030-USA	3	10.5 (9)	2
ODP-32030-xx	3.0	ODP-32040-USA	4	14	3
ODP-32040-xx	4.0	ODP32050-USA	5	18	3
ODP-32055-xx	5.5	ODP-32075-USA	7.5	25 (24)	3
ODP-42075-xx	7.5	ODP-42100-USA	10	39	4
ODP-42110-xx	11	ODP-42150-USA	15	46	4
ODP-42150-xx	15	ODP-42200-USA	20	61	4
ODP-42185-xx	18.5	ODP-42250-USA	25	72	4
ODP-52220-xx	22	ODP-52300-USA	30	90	5
ODP-52300-xx	30	ODP-52400-USA	40	110	5
ODP-52370-xx	37	ODP-52500-USA	50	150	5
ODP-52450-xx	45	ODP-52600-USA	60	180	5
ODP-62055-xx	55	ODP-62075-USA	75	202	6
ODP-62075-xx	75	ODP-62100-USA	100	240	6
ODP-62090-xx	90	ODP-62120-USA	120	300	6

380-480V ±10% - 3 Phase Input					
kW Model Number	kW	HP Model Number	HP	Output Current (A)	Frame Size
ODP-24075-xx	0.75	ODP-24010-USA	1	2.2	2
ODP-24150-xx	1.5	ODP-24020-USA	2	4.1	2
ODP-24220-xx	2.2	ODP-24030-USA	3	5.8	2
ODP-24400-xx	4	ODP-24050-USA	5	9.5	2
ODP-34055-xx	5.5	ODP-34075-USA	7.5	14	3
ODP-34075-xx	7.5	ODP-34100-USA	10	18	3
ODP-34110-xx	11	ODP-34150-USA	15	25 (24)	3
ODP-34150-xx*	15	ODP-34200-USA*	20	30	3
ODP-44185-xx	18.5	ODP-44250-USA	25	39	4
ODP-44220-xx	22	ODP-44300-USA	30	46	4
ODP-44300-xx	30	ODP-44400-USA	40	61	4
ODP-44370-xx	37	ODP-44500-USA	50	72	4
ODP-54450-xx	45	ODP-54600-USA	60	90	5
ODP-54550-xx	55	ODP-54750-USA	75	110	5
ODP-54750-xx	75	ODP-54100-USA	100	150	5
ODP-54900-xx	90	ODP-54120-USA	150	180	5
ODP-64110-xx	110	ODP-64150-USA	160	202	6
ODP64132-xx	132	ODP-64175-USA	200	240	6
ODP-64160-xx	160	ODP-64210-USA	250	300	6

480-525V ±10% - 3 Phase Input (Note : <u>Not UL Approved</u>)					
kW Model Number	kW	HP Model Number	HP	Output Current (A)	Frame Size
ODP-55550-xx	55	N/A		90	5
ODP-55750-xx	75	N/A		110	5
ODP-55900-xx	90	N/A		150	5
ODP-65132-xx	132	N/A		202	6
ODP-65160-xx	160	N/A		240	6
ODP-65200-xx	200	N/A		270	6

500-600V ±10% - 3 Phase Input					
kW Model Number	kW	HP Model Number	HP	Output Current (A)	Frame Size
ODP-25075-xx	0.75	ODP-25010-USA	1	1.7	2
ODP-25150-xx	1.5	ODP-25020-USA	2	3.1	2
ODP-25220-xx	2.2	ODP-25030-USA	3	4.1	2
ODP-25370-xx	3.7	ODP-25050-USA	5	6.1	2
ODP-25550-xx	5.5	ODP-25075-USA	7.5	9.0	2
ODP-35075-xx	7.5	ODP-35100-USA	10	14	3
ODP-35110-xx	11	ODP-35150-USA	15	18	3
ODP-35150-xx	15	ODP-35200-USA	20	24	3
ODP-45220-xx	22	ODP-45300-USA	30	39	4
ODP-45300-xx	30	ODP-45400-USA	40	46	4
ODP-45450-xx	45	ODP-45600-USA	60	62	4

Notes

Output current values shown in brackets are maximum values for UL conformance.

* Indicates models that are not UL listed

Input line choke must be fitted for all size 2 500 volt units

3. Mechanical Installation

3.1. Mechanical dimensions and mounting

3.1.1. Frame Size 1

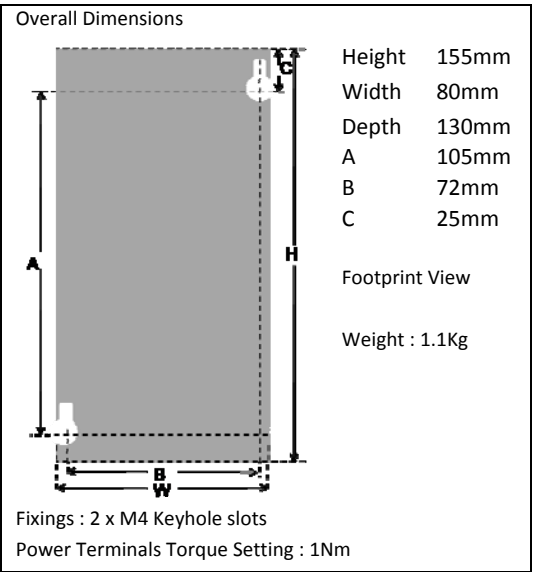
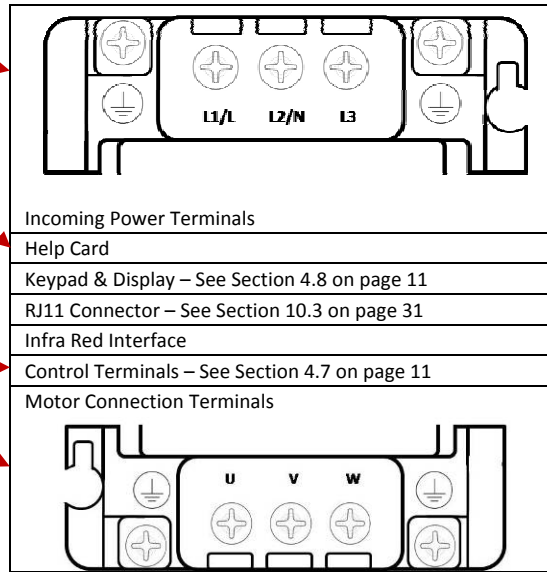
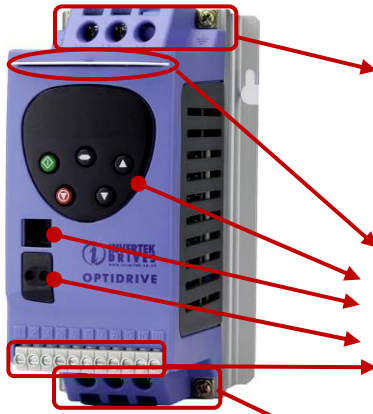

3.1.2. Frame Size 2

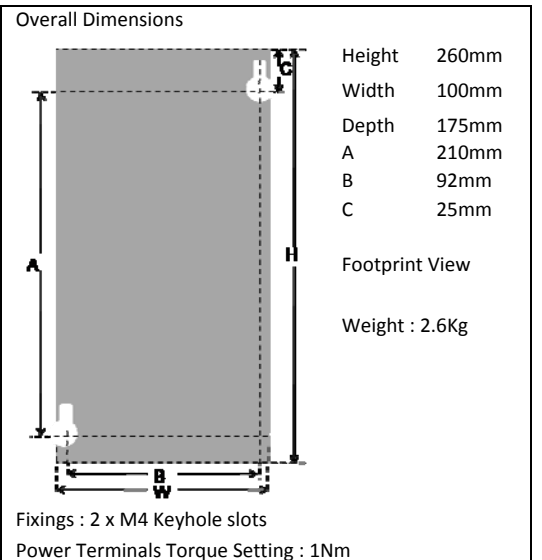
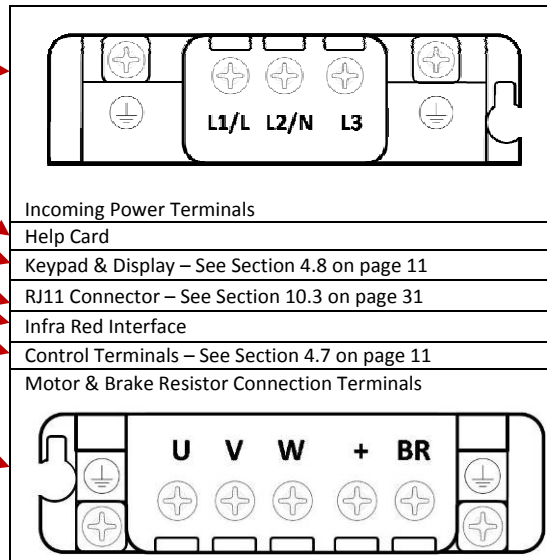
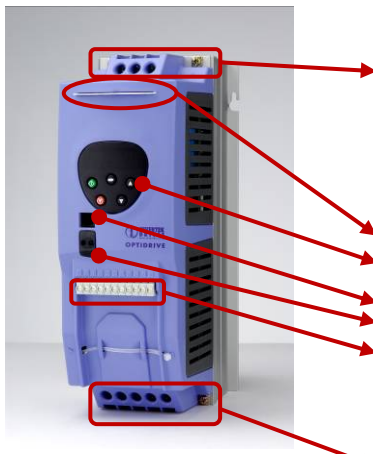

3.1.3. Frame Size 3

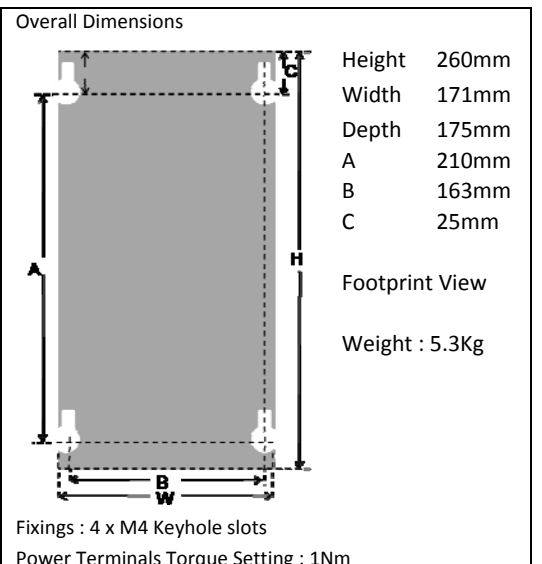
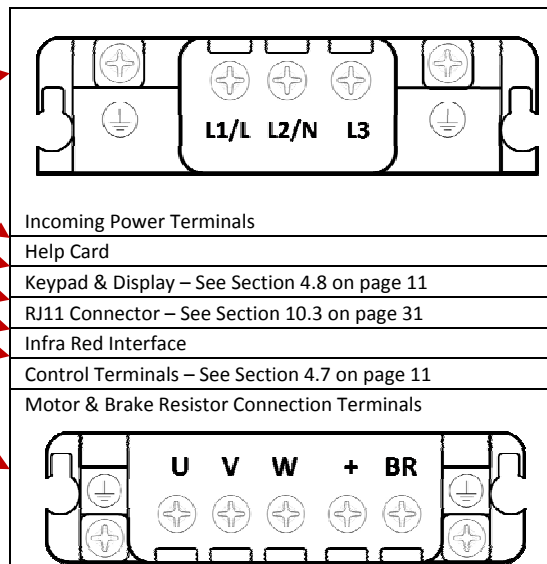
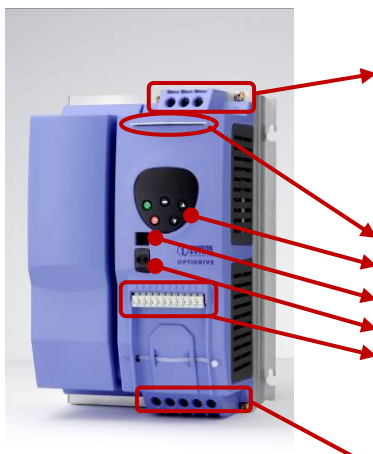

3.1.4. Frame Size 4

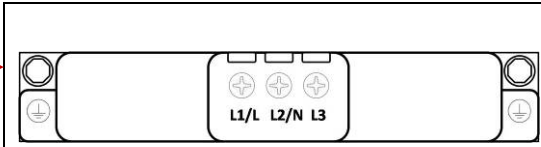
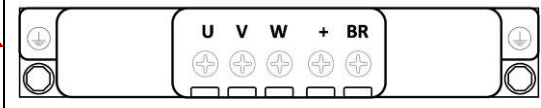

Incoming Power Terminals
Help Card
Keypad & Display – See Section 4.8 on page 11
RJ11 Connector – See Section 10.3 on page 31
Infra Red Interface
Control Terminals – See Section 4.7 on page 11
Motor & Brake Resistor Connection Terminals

Overall Dimensions

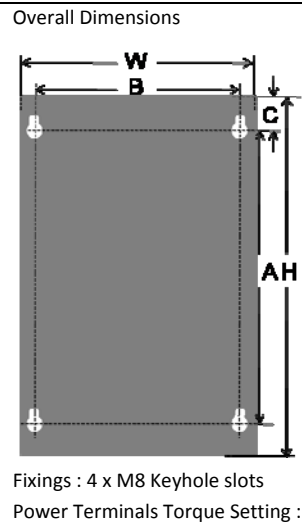

Height	520mm
Width	340mm
Depth	220mm
A	420mm
B	320mm
C	50mm

Footprint View

Weight : 28Kg

Fixings : 4 x M8 Keyhole slots
Power Terminals Torque Setting : 4Nm

3.1.5. Frame Sizes 5 & 6

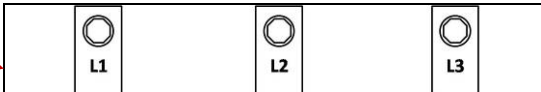
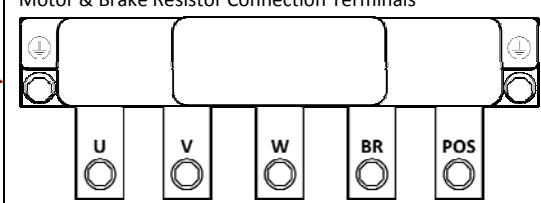

Incoming Power Terminals
Help Card
Keypad & Display – See Section 4.8 on page 11
RJ11 Connector – See Section 10.3 on page 31
Infra Red Interface
Control Terminals – See Section 4.7 on page 11
Motor & Brake Resistor Connection Terminals

Overall Dimensions

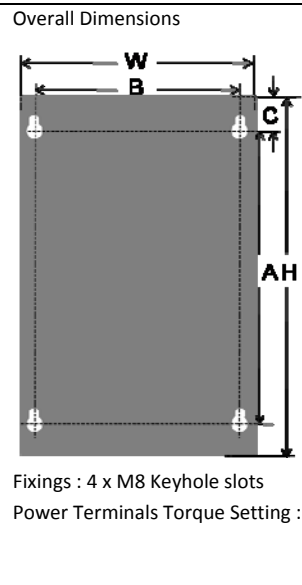

Height	1100mm
Width	340mm
Depth	330mm
A	945mm
B	320mm
C	50mm

Footprint View

Weights :

Size 5 : 67Kg
Size 6 : 55Kg
(+ 27Kg Choke)

Fixings : 4 x M8 Keyhole slots
Power Terminals Torque Setting : 8Nm

3.1.6. Frame Size 6 Additional Input Choke

Optidrive Plus Frame Size 6 is supplied complete with an external Input Choke, which must be installed in the supply line to the drive

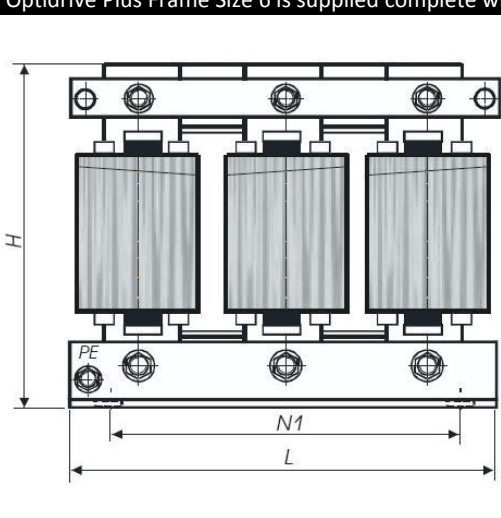

Overall Dimensions

Height H	230mm
Length L	240mm
Depth B	250mm

Mounting Holes

Centres N1	160mm
Centres N2	105mm
Slots D1	8.5 x 22mm

Busbar Connections

Length A1	40mm
Connection	9mm
Diameter D2	

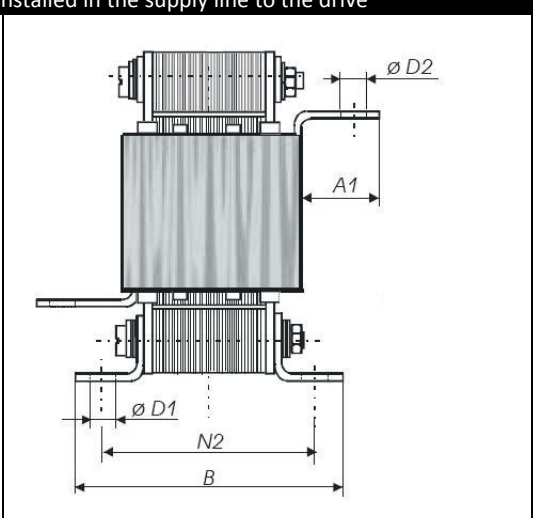

Note : The choke is always supplied with the drive, and MUST be used.

3.2. General

- Store the Optidrive in its box until required. Storage should be clean and dry and within the temperature range -40°C to $+60^{\circ}\text{C}$
- The Optidrive must be installed in a pollution degree 1 or 2 environment

3.3. Enclosure mounting

For applications that require a higher IP rating than the IP20 offered by the standard drive, the drive must be mounted in a suitable metallic enclosure. The following guidelines should be observed for these applications:

- Carefully inspect the Optidrive prior to commencing to ensure it is undamaged
- Install the Optidrive on a flat, vertical, flame-resistant, vibration-free mounting.
- For IP20 Optidrives, install in a suitable enclosure, according to EN60529 if specific Ingress Protection ratings are required.
- Enclosures should be made from a thermally conductive material
- Do not mount flammable material close to the Optidrive
- Where vented enclosures are used, there should be venting above and below the drive to ensure good air circulation – see the diagram below. Air should be drawn in below the drive and expelled above the drive.
- In any environments where the conditions require it, the enclosure must be designed to protect the Optidrive against ingress of airborne dust, corrosive gases or liquids, conductive contaminants (such as condensation, carbon dust, and metallic particles) and sprays or splashing water from all directions.
- High moisture, salt or chemical content environments should use a suitably sealed (non-vented) enclosure.

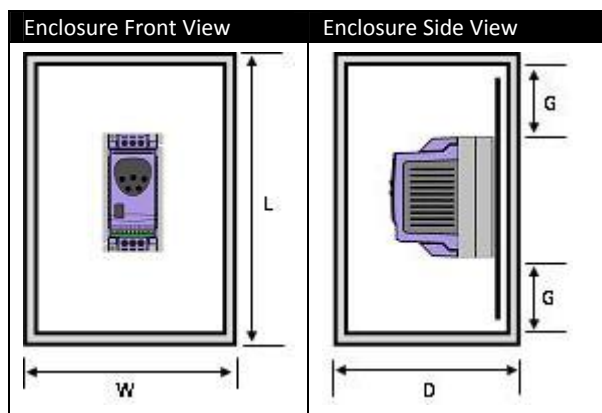

The enclosure design and layout should ensure that the adequate ventilation paths and clearances are left to allow air to circulate through the drive heatsink. Inverterk Drives recommend the following minimum sizes for drives mounted in non-ventilated metallic enclosures:-

Enclosure Minimum Dimensions				
Drive Power rating	L	W	D	G
Size 1 0.75kW 230V	300	250	200	50
Size 1 1.5kW 230V	400	300	250	75
Size 2 1.5kW 230V / 2.2kW 400V	400	300	300	60
Size 2 2.2kW 230V / 4kW 400V	600	450	300	100

For drives mounted in free ventilated enclosures or force ventilated enclosures, Inverterk Drives recommend the following minimum sizes and airflow requirements:-

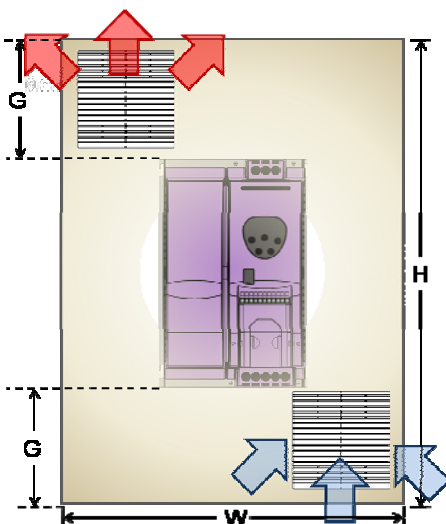



Drive Power Rating	Free-Vented unit			
	L	W	D	G
Size 1 1.5 kW	400	300	150	75
Size 2 4 kW	600	400	250	100
Size 3 15 kW	800	600	300	150
Size 4 22 kW	1000	600	300	200
Size 4 37 kW	-	-	-	-
Size 5 90 kW	-	-	-	-
Size 6 160 kW	-	-	-	-

Force-vented unit				
L	W	D	G	Air Flow
275	150	150	50	$> 15\text{m}^3/\text{h}$
320	200	200	75	$> 45\text{m}^3/\text{h}$
400	250	200	100	$> 80\text{m}^3/\text{h}$
800	500	250	130	$> 300\text{m}^3/\text{h}$
800	500	250	130	$> 300\text{m}^3/\text{h}$
1500	600	400	200	$> 900\text{m}^3/\text{h}$
1600	600	400	250	$> 1000\text{m}^3/\text{h}$

4. Power and Control Connections

4.1. Grounding the Drive

	This manual is intended as a guide for proper installation. Invertek Drives Ltd cannot assume responsibility for the compliance or the non-compliance to any code, national, local or otherwise, for the proper installation of this drive or associated equipment. A hazard of personal injury and/or equipment damage exists if codes are ignored during installation.
	This Optidrive contains high voltage capacitors that take time to discharge after removal of the mains supply. Before working on the drive, ensure isolation of the mains supply from line inputs. Wait ten (10) minutes for the capacitors to discharge to safe voltage levels. Failure to observe this precaution could result in severe bodily injury or loss of life.
	Only qualified electrical personnel familiar with the construction and operation of this equipment and the hazards involved should install, adjust, operate, or service this equipment. Read and understand this manual and other applicable manuals in their entirety before proceeding. Failure to observe this precaution could result in severe bodily injury or loss of life.

Grounding Guidelines

The ground terminal of each Optidrive should be individually connected DIRECTLY to the site ground bus bar (through the filter if installed). Optidrive ground connections should not loop from one drive to another, or to, or from any other equipment. Ground loop impedance must conform to local industrial safety regulations. To meet UL regulations, UL approved ring crimp terminals should be used for all ground wiring connections.

The drive Safety Ground must be connected to system ground. Ground impedance must conform to the requirements of national and local industrial safety regulations and/or electrical codes. The integrity of all ground connections should be checked periodically.

Safety Ground

This is the safety ground for the drive that is required by code. One of these points must be connected to adjacent building steel (girder, joist), a floor ground rod, or bus bar. Grounding points must comply with national and local industrial safety regulations and/or electrical codes.

Motor Ground

The motor ground must be connected to one of the ground terminals on the drive.

Ground Fault Monitoring

If a system ground fault monitor is to be used; only Type B devices should be used to avoid nuisance tripping.

Shield Termination (Cable Screen)

The safety ground terminal provides a grounding point for the motor cable shield. The motor cable shield should be connected to this terminal (drive end) and also be connected to the motor frame (motor end). Use a shield terminating or EMI clamp to connect the shield to the safety ground terminal.

When shielded cable is used for control and signal wiring, the shield should be grounded at both ends of the cable.

4.2. Wiring Precautions

Connect the Optidrive according to section 4.4 Connection Diagram, ensuring that motor terminal box connections are correct. There are two connections in general: Star and Delta. It is essential to ensure that the motor is connected in accordance with the voltage at which it will be operated. For more information, refer to section 4.6 Motor Terminal Box Connections.

For recommended cabling and wiring sizing, refer to section 9.2 Rating tables.

It is recommended that the power cabling should be 3-core or 4-core PVC-insulated screened cable, laid in accordance with local industrial regulations and codes of practice.

4.3. Mains Power Supply

- For 1 phase supply power should be connected to L1/L, L2/N.
- For 3 phase supplies power should be connected to L1, L2, and L3. Phase sequence is not important.
- The Optidrive should be connected to a fixed supply using a suitable disconnecting device between the Optidrive and the AC Power Source. The disconnecting device must conform to the local safety code / regulations.
- The cables should be dimensions according to any local codes or regulations. Guideline dimensions are given in section 9.2.
- Suitable fuses to provide wiring protection should be installed in the incoming supply line, according to the data in section 9.2. The fuses must comply with any local codes or regulations in place. In general, IEC type gG or UL type T fuses are suitable. The operating time of the fuses must be below 0.5 seconds.
- Where allowed by local regulations, suitably dimensioned circuit breakers may be utilised in place of fuses. Thermal overload protection is not required, as the Optidrive provides thermal protection for the motor and motor cable. Guideline dimensions are given in section 9.2.
- When the power supply is removed from the drive, a minimum of 30 seconds should be allowed before re-applying the power. A minimum of 10 minutes should be allowed before removing the terminal covers or connection.
- The maximum permissible short circuit current at the Optidrive Power terminals as defined in IEC60439-1 is 100kA.
- An Input Choke should be installed in the supply line for frame size 1 to 3 Optidrives where any of the following conditions occur:-
 - The incoming supply impedance is low or the fault level / short circuit current is high
 - The supply is prone to dips or brown outs
 - An imbalance exists on the supply (3 phase drives)
 - All installations of Frame Size 2 drives on 575 Volt Supply
- In all other installations, an input choke is recommended to ensure protection of the drive against power supply faults. The recommended chokes can be found in the Invertek Stock Drives Catalogue
- For compliance with CE and C Tick EMC requirements, a symmetrical shielded cable is recommended.

4.4. Connection Diagram

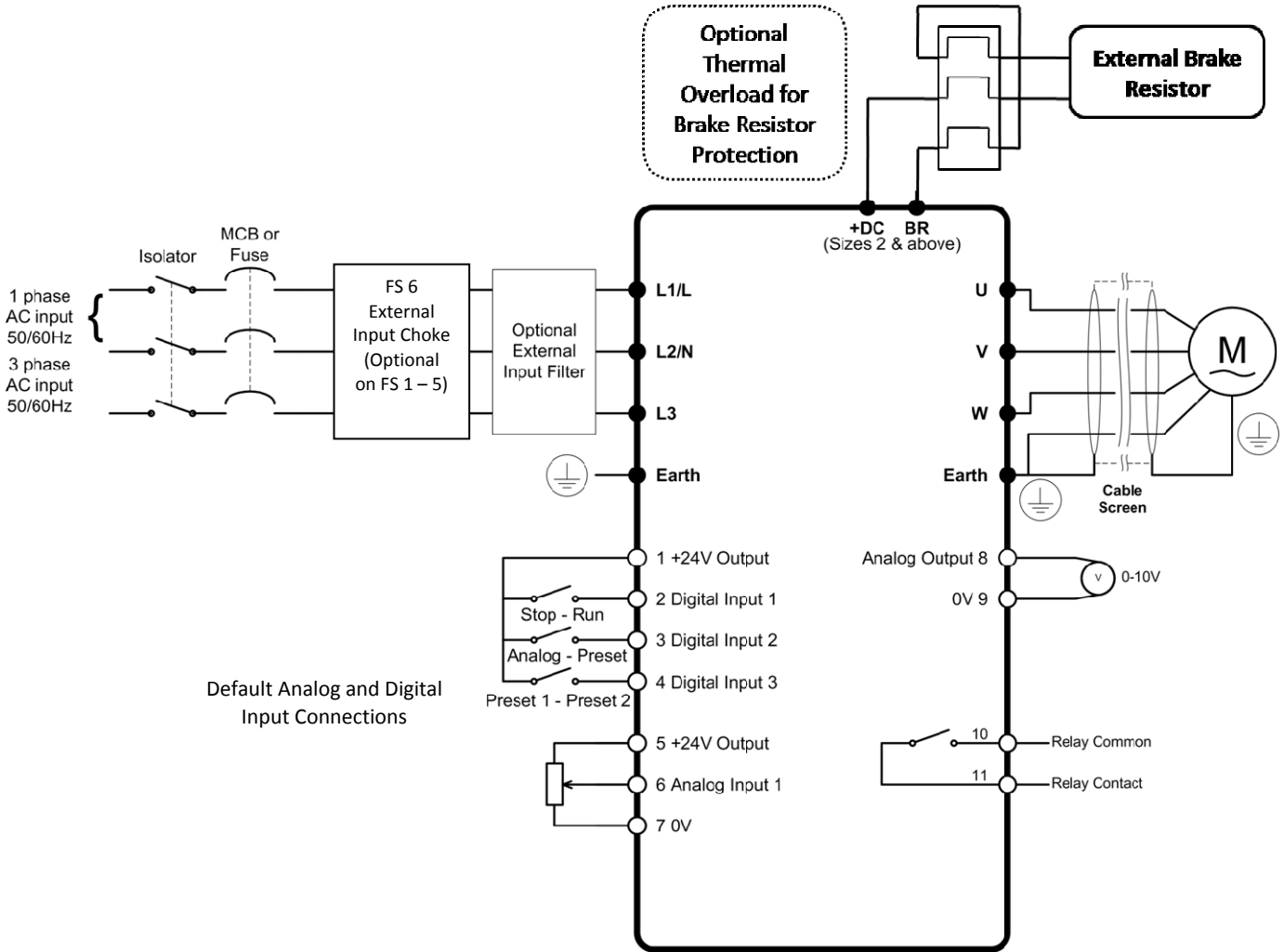

4.5. Motor connections

The motor should be connected to U, V, and W

For drives that have a dynamic brake transistor, an optional external braking resistor can be connected to +DC and BR when required. The brake resistor circuit should be protected by a suitable thermal protection circuit that disconnects the AC supply to the drive in the event of a trip. Further information can be found in the Advanced User Guide.

4.6. Motor Terminal Box Connections

Most general purpose motors are wound for operation on dual voltage supplies; this is indicated on the nameplate of the motor.

This operational voltage is normally selected when installing the motor by selecting either STAR or DELTA connection. STAR always gives the higher of the two voltage ratings.

Incoming Supply Voltage	Motor Nameplate Voltages		Connection
230	230 / 400	Delta	DELTA Δ
400	400 / 690		
400	230 / 400	Star	STAR \star

4.7. Control terminal connections

Default Connections

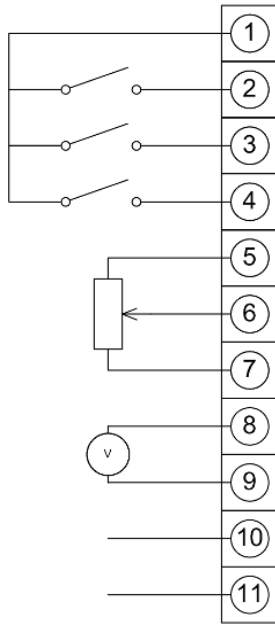

Control Terminal	Signal	Description
1	+24V User Output,	+24V, 100mA user control output
2	Digital Input 1	Positive logic "Logic 1" input voltage range: 8V ... 30V DC "Logic 0" input voltage range: 0V ... 8V DC
3	Digital Input 2 / Digital Output 3	Input : Positive logic "Logic 1" input voltage range: 8V ... 30V DC "Logic 0" input voltage range: 0V ... 8V DC Output : 24V 10mA Max 'Drive Healthy' Output
4	Digital Input 3 / Analog Input 2	Digital : "Logic 1" input voltage range : 8 to 30V DC "Logic 0" input voltage range : 0 to 8 V DC Analog: 0 to 10V, 0 to 20mA or 4 to 20mA
5	+24V User Output	+24V, 100mA, 1kΩ minimum
6	Bipolar analog Input / Digital Input 4	Digital : "Logic 1" input voltage range : 8 to 30V DC "Logic 0" input voltage range : 0 to 8 V DC Analog: 0 to 24V, 0 to 10V, -10 to +10V, -24 to + 24V
7	0V	User ground, connected to terminal 9
8	Analog Output / Digital Output	Analog: 0 to 10V DC, 10 to 0 V DC, 20mA Maximum 4 to 20mA, 20 to 4 mA Digital: 0 to 24V DC, 20mA Maximum
9	0V	User ground, connected to terminal 7
10	Relay Common	Volt free contacts. Maximum load should not exceed 250Vac, 6A / 30Vdc, 5A
11	Relay NO Contact	

4.8. Electromagnetic Compatibility

All Optidrive Plus are designed to high standards of EMC and can optionally be fitted with an internal EMC filter. This EMC filter is designed to reduce the conducted emissions back into the supply via the power cables for compliance with harmonised European standards.

It is the responsibility of the installer to ensure that the equipment or system into which the product is incorporated complies with the EMC legislation of the country of use. Within the European Union, equipment into which this product is incorporated must comply with 89/336/EEC, EMC. When using the internal or optional external filter, the following maximum motor cable lengths apply:-

EMC Category	Screened Motor Cable Length					
	With Internal Filter			With External Filter		
Drive Frame Size	C1	C2	C3	C1	C2	C3
230 Volt, Single Phase Input						
Size 1	1m	5m	25m	25m	50m	100m
Size 2	1m	5m	25m	50m	100m	200m
3 Phase, 400 Volt Input						
Size 2	5m	25m	50m	50m	100m	200m
Size 3	5m	25m	50m	50m	100m	200m
Size 4	5m	25m	50m	50m	100m	200m
Size 5	5m	25m	50m	50m	100m	200m
Size 6	5m	25m	50m	50m	100m	200m
Note	For motor cable lengths greater than 100m, an output dv / dt filter must be used, please refer to the Invertek Stock Drives Catalog for further details					
	For Size 5 and 6 drives, ferrite ring must be installed on the output motor cable, with all three phases of the motor cable being wrapped one turn around the ferrite ring.					
	Vector Speed and Torque control modes may not operate correctly with long motor cables and output filters. It is recommended to operate in V/F mode only for cable lengths exceeding 50m					









5. Operation

5.1. Managing the keypad













The drive is configured and its operation monitored via the keypad and display.

	NAVIGATE	Used to display real-time information, to access and exit parameter edit mode and to store parameter changes	
	UP	Used to increase speed in real-time mode or to increase parameter values in parameter edit mode	
	DOWN	Used to decrease speed in real-time mode or to decrease parameter values in parameter edit mode	
	RESET / STOP	Used to reset a tripped drive. When in Keypad mode is used to Stop a running drive.	
	START	When in keypad mode, used to Start a stopped drive or to reverse the direction of rotation if bi-directional keypad mode is enabled	





5.2. Changing Parameters

Procedure	Display shows...
Power on Drive	StoP
Press and hold the  for >2 seconds	P 1-01
Press the  Key	P 1-02
The  and  can be used to select the desired parameter	P 1-03 etc...
Select the required parameter, e.g. P1-02	P 1-02
Press the  button	0.0
Use the  and  keys to adjust the value, e.g. set to 10	10.0
Press the  key	P 1-02
The parameter value is now adjusted and automatically stored. Press the  key for >2 seconds to return to operating mode	StoP

5.3. Advanced Keypad Operation Short Cuts



Function	When Display shows...	Press...	Result	Example
Fast Selection of Parameter Groups Note : Parameter Group Access must be enabled P1-14 = 101	Px-xx		The next highest Parameter group is selected	Display shows P 1-10 Press  Display shows P 2-01
	Px-xx		The next lowest Parameter group is selected	Display shows P 2-26 Press  Display shows P 1-01
Select lowest Group Parameter	Px-xx		The first parameter of a group is selected	Display shows P 1-10 Press  Display shows P 1-01
Set Parameter to minimum value	Any numerical value (Whilst editing a parameter value)		The parameter is set to the minimum value	When editing P1-01 Display shows 50.0 Press  Display shows 0.0
Adjusting individual digits within a parameter value	Any numerical value (Whilst editing a parameter value)		Individual parameter digits can be adjusted	When editing P1-10 Display shows 10 Press  Display shows -0 Press  Display shows 10 Press  Display shows -10 Press  Display shows 110 Etc...

5.4. Reset All Parameters to Factory Default Settings

To reset all drive parameters to factory default settings, press  +  +  +  for >2s. The display shows **P-dEF**. Press the  button to acknowledge and reset the drive.















5.5. Terminal Control

When delivered, the Optidrive is in the factory default state, meaning that it is set to operate in terminal control mode and all parameters have the default values as indicated in section 6 Parameters.

- Connect the drive to the supply, ensuring the correct voltage and fusing / circuit breaker protection – see section 9.2 on page 27.
- Connect the motor to the drive, ensuring the correct star/delta connection for the voltage rating - see section 4.6 on page 10.
- Enter the motor data from motor nameplate; P1-07 = motor rated voltage, P1-08 = motor rated current, P1-09 = motor rated frequency.
- Connect a control switch between the control terminals 1 and 2 ensuring that the contact is open (drive disabled).
- Connect a potentiometer (1kΩ min to 10 kΩ max) between terminals 5 and 7, and the wiper to terminal 6.
- With the potentiometer set to zero, switch on the supply to the drive. The display will show **StoP**.
- Close the control switch, terminals 1-2. The drive is now 'enabled' and the output frequency/speed are controlled by the potentiometer.
- On first enable from factory default parameters, the Optidrive will carry out an Autotune, and the display shows **Auto-t**. Leave the control switch closed and allow this to complete.
- Following completion of the Autotune, the display shows zero speed in Hz (**H 0.0**) with the potentiometer turned to minimum.
- Turn the potentiometer to maximum. The motor will accelerate to 50Hz, (60Hz for USA drives), the default value of P1-01, under the control of the acceleration ramp time P1-03. The display shows 50Hz (**H 50.0**) at max speed.
- If the potentiometer is turned to minimum, the motor will decelerate to 0Hz, the default minimum speed set in P1-02, under the control of the deceleration ramp P1-04. The output speed can be adjusted anywhere between minimum and maximum speed using the potentiometer.
- To display motor current (Amps), briefly press the  (Navigate) key.
- Press  again to display the motor power.
- Press  again to return to speed display.
- To stop the motor, disable the drive by opening the control switch (terminals 1-2).
- If the enable/disable switch is opened the drive will decelerate to stop at which time the display will show **StoP**.

5.6. Keypad Control

To allow the Optidrive to be controlled from the keypad in a forward direction only, set P1-12 =1:

- Connect the supply and motor as for terminal control above.
- Enable the drive by closing the switch between control terminals 1 & 2. The display will show **StoP**.
- Press the  key. If this is the first enable from factory default parameters, the drive will carry out an Autotune as described above. On completion of the Autotune, the display shows **H 0.0**.
- Press  to increase speed.
- The drive will run forward, increasing speed until  is released.
- Press  to decrease speed. The drive will decrease speed until  is released. The rate of deceleration is limited by the setting in P1-04.
- Press the  key. The drive will decelerate to rest at the rate set in P1-04.
- The display will finally show **StoP** at which point the drive is disabled.
- To preset a target speed prior to enable, press the  key whilst the drive is stopped. The display will show the target speed, use the  &  keys to adjust as required then press the  key to return the display to **StoP**.
- Pressing the  key will start the drive accelerating to the target speed.
- To allow the Optidrive to be controlled from the keypad in a forward and reverse direction, set P1-12 =2:
- Operation is the same as when P1-12=1 for start, stop and changing speed.
- Press the  key. The display changes to **H 0.0**.
- Press  to increase speed
- The drive will run forward, increasing speed until  is released. Acceleration is limited by the setting in P1-03. The maximum speed is the speed set in P1-01.
- To reverse the direction of rotation of the motor, press the  key again.

5.7. Motor Autotuning

Optidrive Plus uses a sophisticated Voltage Vector Control Method as a factory default setting to ensure best possible motor operation. This control method requires the Optidrive to carry out an autotune to measure certain motor parameters prior to operation, to ensure this function operates correctly, and reduce the risk of nuisance tripping.



Whilst the autotune procedure does not drive or spin the motor, the motor shaft may still turn. It is not normally necessary to uncouple the load from the motor; however the user should ensure that no risk arises from the possible movement of the motor shaft.

Autotune after Factory Reset or from Factory Set Parameters

Following a factory reset (See section 5.4), the correct data from the motor nameplate should be entered in P1-07 (Motor Rated Voltage), P1-08 (Motor Rated Current) and P1-09 (Motor Rated Frequency). Providing that P1-08 is adjusted from the factory default setting, the Optidrive will automatically carry out an autotune on the motor the first time it is enabled. During the autotune, the display will show **Auto-t**. The test procedure may take several minutes to complete depending on the motor. Once the autotune is completed, the drive will operate as normal, and no further autotuning will be required unless the motor or drive control mode is changed (P4-01).

User Selected Autotune

The user can program the drive to carry out an autotune if required, as follows:-

Ensure the motor nameplate values are correctly entered as described above.

Set P1-14 = 101 to allow access to Parameter Groups 2, 3 and 4

Set P4-02 = 1 and press the  button.



The autotune will begin immediately when P4-02 is set to 1, and no external enable signal is required. During the autotune procedure, the motor shaft may turn. It is not normally necessary to uncouple the load from the motor; however the user should ensure that no risk arises from the possible movement of the motor shaft.

5.8. Operating in Sensorless Vector Speed Control Mode

Optidrive Plus can be programmed by the user to operate in Sensorless Vector mode, which provides enhanced low speed torque, optimum motor speed regulation regardless of load and accurate control of the motor torque. In most applications, the default Voltage Vector control mode will provide adequate performance, however if Sensorless Vector operation is required, the following procedure should be followed:-

Ensure the motor nameplate values are correctly entered in P1-07 (Motor Rated Voltage), P1-08 (Motor Rated Current) and P1-09 (Motor Rated Frequency)

Set P1-14 = 101 to allow access to parameter groups 2, 3 and 4

The Motor Rated Power Factor from the motor nameplate **MUST** be entered in P4-05. If this data is not available, consult the motor manufacturer for guidance.

Set P4-01 = 0 to select Sensorless Vector Speed Control

Set P4-02 = 1 to carry out an motor autotune

Parameters P4-03 and P4-04 have a significant effect on the behaviour of the motor when operating in vector mode, see section 6.4 for further details, or the Optidrive Advanced User Guide.



The autotune will begin immediately when P4-02 is set to 1, and no external enable signal is required. During the autotune procedure, the motor shaft may turn. It is not normally necessary to uncouple the load from the motor; however the user should ensure that no risk arises from the possible movement of the motor shaft.



5.9. Sensorless Vector Torque Control Mode

For applications which require the drive to control motor torque as opposed to motor speed, the Optidrive Plus can be programmed to operate in Torque Control mode. When operating this way, the drive internal ramp times (P1-03 and P1-04) are disabled except during starting and stopping. Please refer to the Optidrive Plus Advanced User Guide for further information on this.

5.10. Operation of Three Phase drives on Single Phase Supplies

Applies to: - Optidrive Plus, 230 Volt Supply versions, Size 3 and above
Optidrive Plus, 400 Volt Supply versions, Size 2 and above

It is possible to operate the above drive units from a single phase supply of the same rated voltage. When used in this way, the maximum output current capacity is reduced by 50%. In order to operate on a single phase supply, the supply **MUST** be connected to the L1 and L2 terminals of the

drive. The user must then press  +  +  for >2s. The display will show **P-DEF**, and all parameters will be reset to factory default

settings. Press the  button to acknowledge and reset the drive. The maximum motor rated current setting in P1-08 will now be limited to 50% of its original value, and the Phase Loss and Phase Imbalance Protection features will be disabled.

6. Parameters

6.1. Parameter Group 1 – Basic Parameters

Par.	Description	Range	Units	Default	Explanation
P1-01	Maximum Frequency / Speed	P1-02 to 5*P1-09 (max 2000Hz)	Hz Rpm	50 (60)	Maximum speed limit – Hz or rpm. If P1-10 >0, the value entered is in Rpm
P1-02	Minimum Frequency / Speed	0 to P1-01	Hz Rpm	0	Minimum speed limit – Hz or rpm. If P1-10 >0, the value entered is in Rpm
P1-03	Acceleration ramp time	0 to 3000	seconds	5	Acceleration ramp time from 0 to base speed (P1-09) in seconds
P1-04	Deceleration ramp time	0 to 3000	seconds	5	Deceleration ramp time from base speed (P1-09) to standstill in seconds. When set to zero, fastest possible ramp time without trip is activated
P1-05	Stop mode select	0 : Ramp to stop with brown-out ride-through on mains loss 1 : Coast to stop 2 : Ramp to stop with 'fast stop' on mains loss	-	0	0 : When the drive enable signal is removed, the drive will ramp to stop at the rate set in P1-04. If the mains supply is lost, the drive will try to continue running by reducing the speed of the load using the load as a generator. 1 : When the enable signal is removed from the drive, the motor will coast (freewheel) to stop 2 : When the drive enable signal is removed, the drive will ramp to stop at the rate set in P1-04. If the mains supply is lost, the drive will ramp to stop using the P2-25 decel ramp time
P1-06	Energy Optimiser	0: Disabled 1: Enabled	-	0	When enabled, automatically reduces applied motor voltage on light load. Minimum value is 50% of nominal rated voltage (P1-07)
P1-07	Motor rated voltage	0, 20 to 250 0, 20 to 500	Volts	230 400 (460)	Rated (nameplate) voltage of the motor (Volts). Value limited to 250V for low voltage drives.
P1-08	Motor rated current	25% -100% of drive rated current	Amps	Drive rating	Enter the rated (nameplate) current of the motor. This value is used for overload protection
P1-09	Motor rated frequency	25Hz to 2000Hz	Hz	50 (60)	Enter the rated (nameplate) frequency of the motor
P1-10	Motor rated speed	0 to 60 000 rpm	Rpm	0	When non-zero, all speed related parameters are displayed in rpm. Enter the motor rated (nameplate) speed if this is required.
P1-11	Preset Speed 1	-P1-01 to P1-01	Hz / Rpm	50 (60)	Sets the speed the drive runs at when Preset Speed 1 is selected
P1-12	Terminal / Keypad / PID Drive Control Mode Selection	0 : Terminal control 1 : Keypad control – fwd only 2 : Keypad control – fwd and rev 3 : PID Control 4 : Modbus RTU Control	-	0	Primary Control Mode of the drive. 0 : Terminal control 1 : Uni-directional keypad control. Keypad START button does not reverse direction. 2 : Bi-directional keypad control. Keypad START button toggles between forward and reverse. 3 : User PID control with external feedback signal 4 : Modbus RTU Control. See section 10
P1-13	Trip log	Last four trips stored	-	Read only	Previous 4 trips stored in order of occurrence, with the most recent first. Press UP or DOWN to step through all four. The most recent trip is always displayed first. UV trip is only stored once.
P1-14	Extended menu access	Code 0 to 30000	-	0	Set to "101" (default) for extended menu access. Change code in P2-37 to prevent unauthorised access to the Extended Parameter Set

NOTE Default parameter values for Horse Power rated drives are shown in brackets

Following a factory reset, or when installing a drive for the first time, only Group 1 Parameter access is available. To allow access to Parameters Groups 0, 2, 3 and 4, Parameters P1-14 and P2-37 must contain the same value. The factory set value for P2-37 = 101

6.2. Parameter Group 2 - Extended parameters

Par.	Description	Range	Units	Default	Explanation
P2-01	Digital input function select	0 to 22	-	0	Defines the function of the digital inputs depending on the control mode setting in P1-12. See section 7 Analog and Digital Input Configurations for more information.
P2-02	Preset Speed 2	-P1-01 to P1-01	Hz / Rpm	0	Sets jog / preset speed 2
P2-03	Preset Speed 3	-P1-01 to P1-01	Hz / Rpm	0	Sets jog / preset speed 3
P2-04	Preset Speed 4	-P1-01 to P1-01	Hz / Rpm	0	Sets jog / preset speed 4
P2-05	Preset Speed 5	-P1-01 to P1-01	Hz / Rpm	0	Sets jog / preset speed 5
P2-06	Preset Speed 6	-P1-01 to P1-01	Hz / Rpm	0	Sets jog / preset speed 6
P2-07	Preset speed 7	-P1-01 to P1-01	Hz / Rpm	0	Sets jog / preset speed 7
P2-08	Preset speed 8	-P1-01 to P1-01	Hz / Rpm	0	Sets jog / preset speed 8
P2-09	Skip frequency	P1-02 to P1-01	Hz / Rpm	0	Centre point of skip frequency band set up in conjunction with P2-10
P2-10	Skip frequency band	0 to P1-01	Hz / Rpm	0	Width of skip frequency band centred on frequency set in P2-09
P2-11	Analog output / Digital Output 1 Function select	Digital output mode 0 : Drive enabled 1 : Drive healthy 2 : Motor at target speed 3 : Motor Speed >0 4 : Motor speed >= limit 5 : Motor torque >= limit 6 : 2 nd Analog Input >= limit Analog Output Mode 7 : Motor speed 8 : Motor torque 9 : Motor power 10 : Motor current		7	Digital Output Mode. Logic 1 = +24V DC 0 : Logic 1 when the drive is enabled (Running) 1 : Logic 1 When no Fault condition exists on the drive 2 : Logic 1 when the motor speed matches the setpoint speed 3 : Logic 1 when the motor runs above zero speed Options 4 to 6 : the Digital output is enabled using the level set in P2-12h and P2-12L Analog Output Mode 7 : Motor Speed, 0 to 10V = 0 to P-01 8 : Motor torque, 0 to 10V = 0 to 200% of motor rated torque 9 : Motor power, 0 to 10V = 0 to 150% of drive rated power 10 : Motor Current, 0 to 10V = 0 to 200% of P1-08
P2-12h	Digital Output Control High Limit	0 to 200	%	100	With P2-11 = 4 to 6, Digital Output 1 is set to Logic 1 (+24V DC) when the value set in P2-12h is exceeded, and returns to Logic 0 (0V) when the selected value reduces below the limit set in P2-12L
P2-12L	Digital Output Control Low Limit	0 to P2-12h	%	100	
P2-13	User Relay Output Function Select	0 : Drive enabled 1 : Drive healthy 2 : Motor at target speed 3 : Motor Speed >0 4 : Motor speed >= limit 5 : Motor torque >= limit 6 : 2 nd Analog Input >= limit		1	Selects the function assigned to the relay output. 0 : Logic 1 when the drive is enabled (Running) 1 : Logic 1 When no Fault condition exists on the drive 2 : Logic 1 when the motor speed matches the setpoint speed 3 : Logic 1 when the motor runs above zero speed Options 4 to 6 : the Digital output is enabled using the level set in P2-14h and P2-14L
P2-14h	Relay Output Control High Limit	0 to 200	%	100	With P2-13 = 4 to 6, the User Relay Output is set to Logic 1 (+24V DC) when the value set in P2-14h is exceeded, and returns to Logic 0 (0V) when the selected value reduces below the limit set in P2-12L
P2-14L	Relay Output Control Low Limit	0 to P2-14h	%	100	
P2-15	Relay Output Mode	0 : Normally Open 1 : Normally Closed	-	1	Inverts the operating status of the User Relay 0 : Logic 1 = Relay Contacts Closed 1 : Logic 1 = Relay Contacts Open The drive must be powered for the contacts to close
P2-16	Zero Speed Holding Time	0 to 60	S	0.2	Determines the time for which the drive output is held at zero speed when stopping, before the drive output is disabled

Par.	Description	Range	Units	Default	Explanation
P2-17	Start Mode Select	Edge-r Auto-0 Auto-1 to 5	-	Auto-0	Edge-r : Following Power on or reset, the drive will not start if Digital Input 1 remains closed. The Input must be closed following a power on or reset to start the drive. Auto-0 : Following a Power On or Reset, the drive will automatically start if Digital Input 1 is closed. Auto 1 to 5 : Following a Fault, the drive will make up to 5 attempts to restart at 20 second intervals. The drive must be powered down to reset the counter
P2-18	Spin Start Enable	0 : Disabled 1 : Enabled	-	0	When enabled, on start up the drive will attempt to determine if the motor is already rotating, and will begin to control the motor from its current speed. A short delay may be observed when starting motors which are not turning
P2-19	Keypad Restart Mode	0 : Minimum Speed, Edge-r 1 : Previous Speed, Edge-r 2 : Minimum Speed, Auto-r 3: Previous Speed, Auto-r	-	1	Active when P1-12 = 1 or 2 0 : Following a stop and restart, the drive will run at minimum speed 1 : Following a stop and restart, the drive will run at the last setpoint speed 2 : As per setting 0, except that the Run command will be determined by the status of Digital Input 1, and the user is not required to press the keypad start button 3 : As per setting 1, except that the Run command will be determined by the status of Digital Input 1, and the user is not required to press the keypad start button
P2-20	Standby Mode	0 : Disabled 0.0 to 60.0	seconds	0.0	When P2-20 >0, the drive enters standby mode if the minimum speed is maintained for the time period set in P2-20. Note : P2-16 must be set to zero for standby mode to operate
P2-21	Display Scaling Factor	0.000 to 30.000	-	0	Disabled if P2-21 is set to 0. If P2-21 is set >0, the variable selected in P2-22 is multiplied by the factor entered in P2-21, and displayed whilst the drive is running
P2-22	Display Scaling Source	0 : 2 nd Analog Input 1 : Motor Speed 2 : Motor Torque 3 : Motor Current	-	0	
P2-23	Brake Circuit Enable	0 : Disabled 1: Enabled, Low Duty 2: Enabled, High Duty 3 : Enabled, No Protection	-	0	Enables the internal brake chopper on Size 2 and above drives. Settings 1 and 2 provide software monitoring of the braking power consumption. Setting 3 disables the protection, and externally monitoring must be used
P2-24	Effective Switching Frequency	4 to 16 / 24 / 32 / Auto Drive Power Rating Dependent	kHz	16 8 4	Effective power stage switching frequency. Higher frequencies reduce the audible 'ringing' noise from the motor, and improve the output current waveform, at the expense of increased drive losses
P2-25	2 nd Deceleration Ramp time	0 to 3000	seconds	0.0	Deceleration 2 nd ramp down time Selected Automatically on mains power loss if P1-05 = 2 Can also be selected by digital inputs, dependent on P2-01 setting. When set to 0, the drive decelerates as quickly as possible, whilst preventing an overvoltage trip
P2-26	Modbus Communication Baud Rate	t9.6, t19.2, t38.4, t57.6, t115.2 r9.6, r19.2, r38.4, r57.6, r115.2	kbaud	t115.2	Modbus RTU serial data link communication Baud Rate. A 't' Prefix indicates the drive will trip if communication with the network master is lost, after a preset time period. An 'r' Prefix indicates that the Optidrive will Ramp to stop in the event of a loss of communication with the network master, after a preset time period .
P2-27	Drive Communication Address	0: Disabled 1 to 63	-	1	Sets the communication address for the drive when connected on an Optibus or Modbus Network

Par.	Description	Range	Units	Default	Explanation
P2-28	Master / Slave Mode Select	0 : Slave Mode 1 : Master Mode	-	0	When in Master Mode, the drive transmits its operational status via the serial data link. All drives on the data link must have unique addresses. Only one drive can be programmed as a Master
P2-29	Digital / Slave speed reference scaling factor	0 to 500.0	%	100.0	Scaling factor applied to any speed reference on the serial data link, e.g. in Master / Slave operation, a Slave drive will apply this scaling factor to the transmitted Master speed reference
P2-30	Bipolar analog input format	U 0-24 = 0 - 24V DC U 0-10 = 0 - 10V DC -10 -10 = -10 to + 10V DC -24 -24 = -24 to + 24V DC	-	U 0-24	Configures the analog input signal to match the reference connected to terminal 6. Only voltage signals can be directly connected, mA reference signals require an external 500R resistor connection.
P2-31	Bipolar analog input scaling	0 to 500.0	%	100.0	Scales the analog input by this factor, e.g. if P2-30 is set for 0 – 10V, and the scaling factor is set to 200.0%, a 5 volt input will result in the drive running at maximum speed (P1-01)
P2-32	Bipolar analog input offset	-500.0 to 500.0	%	0.0	Sets an offset, as a percentage of the full scale range of the input, which is applied to the analog input signal
P2-33	2 nd analog input format	d 0-24 = Digital U 0-10 = 0 to 10V DC A 4-20 = 4 to 20mA A 0-20 = 0 to 20mA	-	d 0-24	Selects the format for the 2 nd analog input Selecting d 0-24 sets the input up as a digital input.
P2-34	2 nd analog input scaling	0 to 500.0	%	100.0	Scales the 2 nd analog input by the factor set in this parameter
P2-35	Digital speed reference scaling control	0 : Disabled (No Scaling) 1 : Scaled by P2-29 2 : Scaled by P2-29, then bipolar analog input added as an offset 3 : Scaled by P2-29 <i>and</i> by bipolar analog input	-	0	Active in Keypad mode (P1-12 = 1 or 2) and Master / Slave mode only. 1 : Actual Speed = Digital Speed x P2-29 2: Actual Speed = (Digital Speed x P2-29) + bipolar analog reference 3 : Actual Speed = Digital Speed x P2-29 x bipolar analog reference
P2-36	Analog output format	U 0-10 = 0 to 10V A 4-20 = 4 to 20mA U 10-0 = 10 to 0V A 20-4 = 20 to 4mA	-	U 0-10	Selects the analog output signal format
P2-37	Extended menu access code	0 to 9999	-	101	Defines the access code which must be entered in P1-14 to access parameter groups above Group 1
P2-38	Parameter Lock	0 : Unlocked 1 : Locked	-	0	When locked, all parameter changes are prevented
P2-39	Hours Run Counter	0 to 99999	Hours	Read Only	Indicates the number of hours for which the drive has run
P2-40	Drive Type / Rating	N/A	-	Read Only	Read only parameter, showing the drive type and power rating

6.3. Parameter Group 3 – PID Control

Par.	Description	Range	Units	Default	Explanation
P3-01	Proportional gain	0.1 to 30.0	-	2.0	PID Controller Proportional Gain. Higher values provide a greater change in the drive output frequency in response to small changes in the feedback signal. Too high a value can cause instability
P3-02	Integral time constant	0.0 to 30.0	seconds	1.0	PID Controller Integral Time. Larger values provide a more damped response for systems where the overall process responds slowly
P3-03	Differential time constant	0.00 to 1.0	seconds	0.00	PID Differential Time Constant
P3-04	PID operating mode	0 : Direct 1 : Inverse	-	0	Direct operation – Motor speed <i>increases</i> with an increase in the feedback signal Inverse Operation – Motor speed <i>decreases</i> with an increase in the feedback signal
P3-05	PID Setpoint / reference select	0 : Digital 1 : Analog	-	0	Selects the source for the PID Reference / Setpoint 0 : P3-06 is used 1 : Bipolar analog input is used
P3-06	PID digital reference	0 to 100.0	%	0.0	Sets the preset digital PID reference / setpoint
P3-07	PID controller high limit output	P3-08 to 100	%	100	Limits the maximum value output from the PID controller
P3-08	PID controller low limit output	0 to P3-07	%	0	Limits the minimum output from the PID controller
P3-09	User PID output limit / function control	0 : Digital output limits 1 : Analog Upper Limit 2 : Analog Lower Limit 3 : PID added to Bipolar analog input reference	-	0	0 : PID output range limited by P3-07 & P3-08 1 : PID maximum output limited by the signal applied to the bipolar analog input 2 : PID minimum output limited by the signal applied to the bipolar analog input 3 : PID output is added to the speed reference applied to the bipolar analog input
P3-10	PID feedback source select	0 : 2 nd Analog Input 1 : Bipolar analog input	-	0	Selects the source of the PID feedback signal

6.4. Parameter Group 4 – High Performance Motor Control

Par.	Description	Range	Units	Default	Explanation
P4-01	Control Mode	0 : Vector Speed Control 1 : Vector Torque Control 2 : V/f Speed Control	-	2	Selects the motor control method. An autotune must be performed following a change, see section 6.4
P4-02	Motor parameter autotune	0 : Disabled 1 : Enabled	-	0	When set to 1, the drive immediately carries out a non-rotating autotune to measure the motor parameters for optimum control and efficiency
P4-03	Speed controller proportional gain	1 to 4096	-	300	Sets the proportional gain value for the speed controller. Too high a value may cause overshoot when accelerating to setpoint speed, or instability of the motor output speed.
P4-04	Speed controller integral time	0.010 to 1.000	seconds	0.150	Set the integral time for the speed controller. Smaller values provide a faster response in reaction to motor load changes, at the risk of introducing instability
P4-05	Motor power factor	0, 0.50 to 1.00	-	-	Motor nameplate power factor, which must be entered for Vector operation (P4-01 = 0 or 1)
P4-06	Torque reference source select	0 : Preset Value 1 : Bipolar analog input 2 : 2 nd analog input 3 : Modbus RTU 4 : Master / Slave	-	0	When operating in vector mode (P4-01 = 0 or 1), selects the source of the torque reference
P4-07	Maximum torque limit / torque reference	0 to 200	%	200	If P4-01 = 1 and P4-06 = 0, sets the preset torque reference If P4-01 = 0, sets the maximum torque limit
P4-08	Minimum torque limit	0.0 to 150.0	%	0.0	Sets a minimum torque limit, see the warning below
P4-09	V/f characteristic adjustment frequency	0 to P1-09	Hz	0	When operating in V/f mode (P4-01 = 2), sets a frequency point at which the voltage applied in P4-10 is applied to the motor. Care must be taken to avoid overheating and damaging the motor when using this feature
P4-10	V/f characteristic adjustment voltage	0 to P1-07	-	0	In conjunction with P4-09, in V/f mode (P4-01 = 2), sets the voltage applied to the motor at the adjustment frequency set in P4-09



Incorrect adjustment of parameters in menu group 4 can cause unexpected behaviour of the motor and any connected machinery. It is recommended that these parameters are only adjusted by experienced users.

6.5. Parameter Group 0 – Monitoring Parameters (Read Only)

Par.	Description	Display range	Units	Explanation
P0-01	Bipolar analog input value	-100 to 100	%	100% = max input voltage
P0-02	2nd Analog input value	0 to 100	%	100% = max input voltage
P0-03	Post Ramp Speed Reference	-500 to 500	%	100% = P1-09
P0-04	Digital speed reference	-P1-01 to P1-01	Hz / Rpm	Digital speed reference
P0-05	Torque controller reference	0 to 200	%	Torque reference setpoint
P0-06	PID Reference	0 to 100	%	PID reference / setpoint
P0-07	PID Feedback	0 to 100	%	PID controller feedback value
P0-08	PID error	0 to 100	%	Actual PID error
P0-09	PID P Term	0 to 100	%	Proportional component
P0-10	PID I term	0 to 100	%	Integral component
P0-11	PID D term	0 to 100	%	Differential component
P0-12	PID Output	0 to 100	%	Output from PID controller
P0-13	Output Torque	0 to 200	%	100% = motor rated torque
P0-14	Magnetising current	Drive dependent	A	Motor rms magnetising current
P0-15	Rotor Current	Drive dependent	A	Rotor rms current
P0-16	Field Strength	0 to 100	%	Magnetic field strength
P0-17	Stator resistance	Drive dependent	Ohms	Phase to phase stator resistance
P0-18	Stator Inductance	Drive dependent	H	Stator inductance
P0-19	Rotor resistance	Drive dependent	Ohms	Calculated rotor resistance
P0-20	DC Bus Voltage	0 to 1000	Volts	Internal DC Bus voltage
P0-21	Drive Temperature	0 to 120	°C	Measured heatsink temperature
P0-22	Supply voltage L1 – L2	Drive dependent	Volts	Phase to phase supply voltage
P0-23	Supply voltage L2 – L3	Drive dependent	Volts	Phase to phase supply voltage
P0-24	Supply voltage L3 – L1	Drive dependent	Volts	Phase to phase supply voltage
P0-25	Estimated rotor speed	Drive dependent	Hz / Rpm	In vector mode, estimated speed of motor
P0-26	kWh meter	0 to 999.9	kWh	Cumulative energy consumption
P0-27	MWh meter	0 to 60,000	MWh	Cumulative energy consumption
P0-28	Software ID – IO Processor	Drive dependent	-	Version number & checksum
P0-29	Software ID – Motor Control	Drive dependent	-	Version number & checksum
P0-30	Drive serial number	Drive dependent	-	Unique drive serial number

7. Analog and Digital Input Configurations

7.1. Terminal mode (P1-12 =0)

P2-01	Digital input 1 (T2)	Digital input 2 (T3)	Digital input 3 (T4)	Analog input (T6)
0	Open: Stop (disable) Closed: Run (enable)	Open : Bipolar analog speed ref Closed : Preset speed ref	Open : Preset Speed 1 Closed : Preset Speed 2	Bipolar analog input
1	Open: Stop (disable) Closed: Run (enable)	Open: Preset Speed 1 Closed: Preset speed 2	Open: Preset speed 1 / 2 Closed: Preset speed 3	Open : Preset Speed 1 / 2 / 3 Closed : Preset Speed 4
2	Open: Stop (disable) Closed: Run (enable)	Digital Input 2	Digital Input 3	Bipolar analog input
		Open	Open	Open
		Closed	Open	Open
		Open	Closed	Open
		Closed	Closed	Open
		Open	Open	Closed
		Closed	Open	Closed
3	Open: Stop (disable) Closed: Run (enable)	Open	Open	Open
		Closed	Closed	Open
		Open	Open	Closed
		Closed	Open	Closed
		Open	Closed	Closed
		Closed	Closed	Closed
		Closed	Closed	Closed
4	Open: Stop (disable) Closed: Run (enable)	Open : Forward Closed : Reverse	Open: Bipolar analog ref Closed: Preset Speed 1	Bipolar analog input
5	Open: Stop (disable) Closed: Run (enable)	Open : Forward Closed : Reverse	Analog input 2 (E.g. Torque reference)	Bipolar analog input
6	Open: Stop (disable) Closed: Run (enable)	Open : Forward Closed : Reverse	Digital Input 3	Bipolar analog input
			Open	Open
			Closed	Open
			Open	Closed
7	Open: Stop (disable) Closed: Fwd Run (enable)	Open: Stop (disable) Closed: Rev Run (enable)	External trip input : Open: Trip, Closed: No Trip	Bipolar analog input
8	Open: Stop (disable) Closed: Fwd Run (enable)	Open: Stop (disable) Closed: Rev Run (enable)	Open: Bipolar analog speed ref Closed: Preset Speed 1	Bipolar analog input
9	Open: Stop (disable) Closed: Forward Run (enable)	Open: Stop (disable) Closed: Reverse Run (enable)	Digital Input 3	Bipolar analog input
			Open	Open
			Closed	Open
			Open	Closed
10	Open: Stop (disable) Closed: Forward Run (enable)	Open: Stop (disable) Closed: Reverse Run (enable)	External trip input : Open: Trip, Closed: No Trip	Bipolar analog input
11	Open: Stop (disable) Closed: Run (enable)	Open : Bipolar analog speed ref Closed : Preset speed 1	External trip input : Open: Trip, Closed: No Trip	Bipolar analog input
12	Open: Stop (disable) Closed: Run (enable)	Open : Preset Speed 1 Closed : Bipolar analog speed ref	External trip input : Open: Trip, Closed: No Trip	Bipolar analog input
13	Normally Open (NO) Momentarily Close to Run	Normally Closed (NC) Momentarily Open to Stop	Open: Bipolar analog speed ref Closed: Preset Speed 1	Bipolar analog input
14	Normally Open (NO) Momentarily Close to Run Fwd	Normally Closed (NC) Momentarily Open to Stop	Normally Open (NO) Momentarily Close to Run Rev	Bipolar analog input
15	Open: Stop (disable) Closed: Run (enable)	Open : Forward Closed : Reverse	Open: Decel Ramp 1 (P1-04) Closed: Decel Ramp 2 (P2-25)	Bipolar analog input
16	Open: Stop (disable) Closed: Run (enable)	Open : Forward Closed : Reverse	Open: Decel Ramp 1 (P1-04) Closed: Decel Ramp 2 (P2-25)	Open: Preset Speed 1 Closed : Preset speed 2
17	Normally Open (NO) Momentarily Close to Run Fwd	Normally Closed (NC) Momentarily Open to Stop	Normally Open (NO) Momentarily Close to Run Rev	Open: Preset Speed 1 Closed : Keypad Speed Ref
18	Open: Stop (disable) Closed: Run (enable)	Digital Input 2	Digital Input 3	Preset Speed Ref
		Open	Open	Preset Speed 1
		Closed	Open	Preset Speed 2
		Open	Closed	Preset Speed 3
19	Open: Stop (disable) Closed: Run (enable)	Open : Bipolar analog speed ref Closed : Analog input 2 speed ref	Open: Preset Speed 4 Closed : Preset Speed 4	Open : Preset Speed Ref Closed : Keypad Speed Ref
20	Open: Stop (disable) Closed: Run (enable)	Open : Bipolar analog speed ref Closed : Analog input 2 speed ref	Analog input 2	Bipolar analog input
21	Open: Stop (disable) Closed: Run (enable)	Digital Output : Drive Healthy = +24V	Open : Bipolar analog speed ref Closed : Preset Speed 1	Bipolar analog input
22	Open: Stop (disable) Closed: Run (enable)	Digital Output : Drive Healthy = +24V	Open : Forward Closed : Reverse	Bipolar analog input
22	Open: Stop (disable) Closed: Run (enable)	Digital Output : Drive Healthy = +24V	External trip input : Open: Trip, Closed: No Trip	Bipolar analog input





NOTE

Negative Preset Speeds will be inverted if Run Reverse selected.

The external trip input can be used to connect a motor thermistor by connecting between terminals 1 and 4

7.2. Keypad mode (P1-12 = 1 or 2)

P2-01	Digital input 1 (T2)	Digital input 2 (T3)	Digital input 3 (T4)	Bipolar analog input (T6)	
0	Open: Stop (disable) Closed: Run (enable)	Closed : remote UP push-button	Closed : remote DOWN push-button	No Function	
		When stopped, closing inputs 2 & 3 simultaneously starts the drive			
1	Open: Stop (disable) Closed: Run (enable)	Closed : remote UP push-button	External trip input : Open: Trip, Closed: No Trip	Closed : remote DOWN push-button	
2	Open: Stop (disable) Closed: Run (enable)	Closed : remote UP push-button	Open: Digital speed ref Closed: Preset speed 1	Open : Forward Closed : Reverse	
3..9, 13, 14 & 16	Open: Stop (disable) Closed: Run (enable)	Closed : remote UP push-button	Closed : remote DOWN push-button	Open : Forward Closed : Reverse	
		When stopped, closing inputs 2 & 3 simultaneously starts the drive			
10	Open: Stop (disable) Closed: Run (enable)	Open : Digital speed ref Closed : Bipolar analog speed ref	External trip input Open: Trip, Closed: No Trip	Bipolar analog input	
11	Open: Stop (disable) Closed: Run (enable)	Open : Digital speed ref Closed : Preset speed 1	External trip input Open: Trip, Closed: No Trip	Open : Forward Closed : Reverse	
12	Open: Stop (disable) Closed: Run (enable)	Open : Preset speed 1 Closed : Digital speed ref	External trip input Open: Trip, Closed: No Trip	Open : Forward Closed : Reverse	
15	Open: Stop (disable) Closed: Run (enable)	Open : Digital speed ref Closed : Preset speed 1	Open: Decel Ramp 1 (P1-04) Closed: Decel Ramp 2 (P2-25)	Open : Forward Closed : Reverse	
17	Open: Stop (disable) Closed: Run (enable)	Open : Digital speed ref Closed : Bipolar analog speed ref	Open : Digital / Analog ref Closed : Preset speed 1	Bipolar analog input	
18	Open: Stop (disable) Closed: Run (enable)	Open : Digital speed ref Closed : Preset speed ref	Digital Input 3	Bipolar analog input	Preset reference
			Open	Open	Preset Speed 1
			Closed	Open	Preset Speed 2
			Open	Closed	Preset Speed 3
			Closed	Closed	Preset Speed 4
19	Open: Stop (disable) Closed: Run (enable)	Open : Digital speed ref Closed : Analog input 2 ref	Analog input 2	Open : Forward Closed : Reverse	
20, 21	Open: Stop (disable) Closed: Run (enable)	Digital Output : Drive Healthy = +24V	Open : Digital speed ref Closed : Preset speed 1	Open : Forward Closed : Reverse	
22	Open: Stop (disable) Closed: Run (enable)	Digital Output : Drive Healthy = +24V	External trip input Open: Trip, Closed: No Trip	Open : Forward Closed : Reverse	

NOTE	By default, if the enable signal is present the drive will not Enable until the  button is pressed. To automatically enable the drive when the enable signal is present set P2-19 = 2 or 3. This then disables the use of the  & STOP buttons
	In keypad mode, the speed can be adjusted using the  &  keys on the built in keypad, or a remote mounted Optiport Plus keypad, in addition to pushbuttons connected to the digital inputs
	The reverse input only functions under the following conditions :- <ul style="list-style-type: none"> • P1-12 = 1, P2-19 = 2 or 3. P2-35 must not be 2 or 3 • P1-12 = 2. P 2-35 must not be 2 or 3
	The external trip input can be used to connect a motor thermistor by connecting between terminals 1 and 4
	When P1-12 =2, the direction of motor can be reversed by <ul style="list-style-type: none"> • pressing the  button • Closing the reverse input (When using a setting of P2-01 that includes this function) • Using a negative speed reference (e.g. select a preset speed of -10Hz) <p>Since all of these functions can be active at once, care must be taken to ensure the motor always turns in the correct direction.</p>

7.3. User PI control mode (P1-12 = 3)

P2-01	Digital input 1 (T2)	Digital input 2 (T3)	Digital input 3 / Analog input 2 (T4)	Bipolar analog input (T6)
0..10, 13..16, 18	Open: Stop (disable) Closed: Run (enable)	No Function	Analog input 2	Bipolar analog input
11	Open: Stop (disable) Closed: Run (enable)	Open : PID control Closed : Preset speed 1	External trip input Open: Trip, Closed: No Trip	Bipolar analog input
12	Open: Stop (disable) Closed: Run (enable)	Open : Preset speed 1 Closed : PID control	External trip input Open: Trip, Closed: No Trip	Bipolar analog input
17	Open: Stop (disable) Closed: Run (enable)	Open : PID Control Closed : Bipolar analog ref	Analog input 2	Bipolar analog input
19	Open: Stop (disable) Closed: Run (enable)	Open : PID Control Closed : Analog input 2 ref	Analog input 2	Bipolar analog input
20, 21	Open: Stop (disable) Closed: Run (enable)	Digital Output : Drive Healthy = +24V	Analog input 2	Bipolar analog input
22	Open: Stop (disable) Closed: Run (enable)	Digital Output : Drive Healthy = +24V	External trip input Open: Trip, Closed: No Trip	Bipolar analog input

NOTE

When P3-05 = 1, Bipolar analog input controls PID setpoint. The feedback must then be connected to Analog input 2 and P3-10 must be set to 0 (Default setting)
The external trip input only functions when the feedback source is the Bipolar analog input (P3-10 = 1)

For further information on configuring the PID controller for typical feedback applications, please refer to the Advanced User Guide.

7.4. Modbus Control Mode (P1-12=4)

P2-01	Digital input 1 (T2)	Digital input 2 (T3)	Digital input 3 / Analog input 2 (T4)	Bipolar analog input (T6)	
0..2, 4, 6..9, 13..16, 18	Open: Stop (disable) Closed: Run (enable)	No Function	No Function	Bipolar analog input (No Function)	
3	Open: Stop (disable) Closed: Run (enable)	Open : Forward Closed : Reverse	Open: Modbus Speed Reference Closed: Preset Speed 1 Reference	Bipolar analog input (No Function)	
5	Open: Stop (disable) Closed: Run (enable)	Open : Modbus Speed Ref Closed : Preset Speed	Digital Input 3	Bipolar Analog Input	
			Open	Open	Preset Speed 1
			Closed	Open	Preset Speed 2
			Open	Closed	Preset Speed 3
10	Open: Stop (disable) Closed: Run (enable)	Open : Master Speed Ref Closed : Digital Speed Ref	External trip input	Bipolar analog input (No Function)	
			Open: Trip, Closed: No Trip		
11	Open: Stop (disable) Closed: Run (enable)	Open : Master Speed Ref Closed : Preset Speed 1	External trip input Open: Trip, Closed: No Trip	Bipolar analog input (No Function)	
12	Open: Stop (disable) Closed: Run (enable)	Open : Master Speed Ref Closed : Bipolar Analog Ref	External trip input Open: Trip, Closed: No Trip	Bipolar analog input (No Function)	
17	Open: Stop (disable) Closed: Run (enable)	Open : Master Speed Ref Closed : Bipolar Analog Ref	Open: Modbus / Analog Ref Closed: Preset Speed 1	Bipolar analog input (No Function)	
19	Open: Stop (disable) Closed: Run (enable)	Open : Master Speed Ref Closed : Analog Input 2 Ref	Analog Input 2	Bipolar analog input (No Function)	
20, 21	Open: Stop (disable) Closed: Run (enable)	Digital Output : Drive Healthy = +24V	Open : Master Speed Ref Closed : Preset Speed 1	Bipolar analog input (No Function)	
22	Open: Stop (disable) Closed: Run (enable)	Digital Output : Drive Healthy = +24V	External trip input Open: Trip, Closed: No Trip	Bipolar analog input (No Function)	

8. Troubleshooting

8.1. Fault messages

Fault Code	Description	Corrective Action
P-dEF	Factory Default parameters have been loaded	Press STOP key, drive is ready to configure for particular application
O-I hO-I	Instantaneous over current on drive output. Excess load on the motor. Over temperature on the drive heatsink	If the fault occurs immediately when enabling the drive, disconnect the motor cable from the output terminals of the drive and restart the drive. If the fault re-occurs with no motor connected, contact your local Invertek Sales Partner. If the drive runs correctly with not motor connected, check the motor, motor cable and any connections or junction boxes for phase – phase and phase – earth short circuits. Wherever possible, motors and connection cables should be checked with a high voltage insulation tester (Megga) prior to connection to the drive. Ensure that no switching devices, such as contactors or local isolators are switching during operation of the drive. Check the motor cable length does not exceed the specified maximum Ensure the motor nameplate parameters are correctly entered, P1-07, P1-08, P1-09. If operating in Vector mode (P4-01 – 0 or 1), also check the motor power factor in P4-05. Ensure an autotune has been successfully completed for the connected motor. Check the load mechanically for a jam or stalled condition, or shock loads. Increase the ramp up time in P1-03. If operating in Vector mode (P4-01 – 0 or 1), reduce the speed loop gain in P4-03
I- t-trP	Drive has tripped on overload after delivering >100% of value in P1-08 for a period of time.	Check to see when the decimal points are flashing (drive in overload) and either increase acceleration rate or reduce the load. Check motor cable length is within spec. Ensure the motor nameplate parameters are correctly entered, P1-07, P1-08, and P1-09. If operating in Vector mode (P4-01 – 0 or 1), also check the motor power factor in P4-05. Ensure an autotune has been successfully completed for the connected motor. Check the load mechanically to ensure it is free, and no jams, blockages or other mechanical faults exist
OI -b	Brake channel over current	Over current in the brake resistor circuit. Check the cabling to the brake resistor. Check the brake resistor value. Ensure minimum resistance values form the rating tables are observed.
OL-br	Brake resistor overload	Brake resistor overload. Increase deceleration time, reduce load inertia or add further brake resistors in parallel, observing the minimum resistance value for the drive in use.
PS-trP	Fast over current trip	Check wiring to motor, look for ph-ph or ph-Earth short circuit. Check drive ambient temp, additional space or cooling needed? Check drive is not forced into overload.
O-Uo It	Over voltage on DC bus	Supply problem, or increase decel ramp time P1-04.
U-Uo It	Under voltage on DC bus	This occurs routinely when power is switched off. If it occurs during running, check power supply voltage.
O-t	Heatsink over temperature	Check drive ambient temp. Additional space or cooling required.
U-t	Under temperature	Trip occurs when ambient temperature is less than -10°C. Temperature must be raised over -10°C in order to start the drive.
th-FLt	Faulty thermistor on heatsink.	Refer to your IDL Authorised Distributor.
E-tr, iP	External trip (on digital Input 3)	E-trip requested on digital input 3. Normally closed contact has opened for some reason. If motor thermistor is connected check if the motor is too hot.
SC-trP	Comms loss trip	Check communication link between drive and external devices. Make sure each drive in the network has its unique address.
P-LOSS	Input phase loss trip	Drive intended for use with a 3 phase supply has lost one input phase. Check incoming supply and fuses.
Ph-I b	Phase Imbalance	Mains incoming supply voltage has an imbalance of >3% for over 30 seconds. Check incoming supply and fuses
dARA-F	Internal memory fault.	Parameters not saved, defaults reloaded. Try again. If the problem re-occurs, refer to your local Invertek Sales Partner.
At-F01	Autotune Failed	Measured motor stator resistance varies between phases. Ensure the motor is correctly connected and free from faults. Check the windings for correct resistance and balance.
At-F02		Measured motor stator resistance is too large. Ensure the motor is correctly connected and free from faults. Check that the power rating corresponds to the power rating of the connected drive.
At-F03		Measured motor inductance is too low. Ensure the motor is correctly connected and free from faults.
At-F04		Measured motor inductance is too large. Ensure the motor is correctly connected and free from faults. Check that the power rating corresponds to the power rating of the connected drive.
At-F05		Measured motor parameters are not convergent. Ensure the motor is correctly connected and free from faults. Check that the power rating corresponds to the power rating of the connected drive.
SP in-F	Spin Start Failure	Spin start function (P2-18=1) failed to detect motor speed Check motor and connections. Ensure motor speed is less than maximum speed (P1-01). Make sure motor base frequency (P1-09) is <100Hz
tor-OL	Over torque trip	The user programmable torque limit has been exceeded. Refer to the Optidrive Plus Advanced User Guide for further information.
4-20 F	4-20mA Input Signal Loss	The level of the 4-20mA signal applied to analog input 2 (Terminal 4) has dropped below the minimum threshold of 3mA. Check for wiring or signal transducer faults

9. Technical data

9.1. Environmental

Operational ambient temperature range: -10 ... 50°C, Frost and condensation free

Storage ambient temperature range: -40 ... 60°C

Maximum altitude: 2000m. Derate above 1000m : 1% / 100m

Maximum humidity: 95%, non-condensing

9.2. Rating tables

200-240V ±10% - 1 Phase Input 3 Phase Output with Internal RFI Filter

Model (kW)	kW	Model (HP)	HP	Frame Size	Nominal Input Current	Fuse or MCB (type B)	Supply Cable Size	Nominal Output Current	150% Output Current 60 secs	Motor Cable Size	Max Motor Cable Length	Min Brake Res Value
					Amps	Amps	mm ²	Amps	Amps	mm ²	m	Ω
ODP-12037	0.37	ODP-12005-USA	0.5	1	6.7	6	1	2.3	3.45	1	25	-
ODP-12075	0.75	ODP-12010-USA	1	1	12.5	10	1.5	4.3	6.45	1	25	-
ODP-12150	1.5	ODP-12020-USA	2	1	19.3	20	4	7	10.5	1.5	25	-
ODP-22150	1.5	ODP-22020-USA	2	2	19.3	20	4	7	10.5	1.5	100	33
ODP-22220	2.2	ODP-22030-USA	3	2	28.8	32	6	10.5	15.75	1.5	100	22
NOTE	For cUL compliance, fuse type Bussmann KTN-R / KTS-R or equivalent must be used											

200-240V ±10% - 3 Phase Input drive model set for 1 Phase Operation (See section 5.10) 3 Phase Output with Internal RFI Filter

Model	kW	Model	HP	Frame Size	Nominal Input Current	Fuse or MCB (type B)	Supply Cable Size	Nominal Output Current	150% Output Current 60 secs	Motor Cable Size	Max Motor Cable Length	Min Brake Res Value
					Amps	Amps	mm ²	Amps	Amps	mm ²	m	Ω
ODP-32030	1.5	ODP-32040-USA	2	3	19.3	20	4	7	11.5	1.5	100	15
ODP-32040	2.2	ODP-32050-USA	3	3	28.8	32	6	9	13.5	1.5	100	15
ODP-32055	3	ODP-32075-USA	4	3	31.3	40	6	12.5 (12)	18.75 (18)	2.5	100	15
ODP-42075	4	ODP-42100-USA	5	4	58.3	63	10	19.5	29.25	2.5	100	6
ODP-42110	5.5	ODP-42150-USA	7.5	4	67.6	80	16	23	34.5	4	100	6
ODP-42150	7.5	ODP-42200-USA	10	4	87.0	100	25	30.5	45.25	10	100	6
ODP-42185	9	ODP-42250-USA	12	4	96.1	100	25	36	54	10	100	6
ODP-52220	11	ODP-52300-USA	15	5	115.4	125	35	45	67.5	16	100	3
ODP-52300	15	ODP-52400-USA	20	5	146.1	160	50	55	82.5	16	100	3
ODP-52370	18.5	ODP-52500-USA	25	5	187.8	200	70	75	112.5	25	100	3
ODP-52450	22	ODP-52600-USA	30	5	220.6	250	90	90	135	25	100	3
ODP-62055	30	ODP-62075-USA	40	6	271.5	315	120	101	151.5	35	100	3
ODP-62075	37	ODP-62100-USA	50	6	319.6	400	120	120	180	55	100	3
ODP-62090	45	ODP-62120-USA	60	6	378.0	400	170	150	225	70	100	3
NOTE	Values shown in brackets are the maximum for UL applications For cUL compliance, fuse type Bussmann KTN-R / KTS-R or equivalent must be used											

200-240V ±10% - 3 Phase Input 3 Phase Output with Internal RFI Filter

Model	kW	Model	HP	Frame Size	Nominal Input Current	Fuse or MCB (type B)	Supply Cable Size	Nominal Output Current	150% Output Current 60 secs	Motor Cable Size	Max Motor Cable Length	Min Brake Res Value
					Amps	Amps	mm ²	Amps	Amps	mm ²	m	Ω
ODP3-22150	1.5	ODP3-22020-USA	2	2	9.2	16	2.5	7	10.5	1.5	100	33
ODP3-22220	2.2	ODP3-22030-USA	3	2	13.7	20	4	10.5 (9)	15.75 (13.5)	1.5	100	22
ODP-32030	3	ODP-32040-USA	4	3	16.1	20	4	14	21	1.5	100	15
ODP-32040	4	ODP-32050-USA	5	3	17.3	32	6	18	27	1.5	100	15
ODP-32055	5.5	ODP-32075-USA	7.5	3	25	40	6	25 (24)	37.5 (36)	2.5	100	15
ODP-42075	7.5	ODP-42100-USA	10	4	46.6	50	10	39	57	2.5	100	6
ODP-42110	11	ODP-42150-USA	15	4	54.1	63	16	46	69	4	100	6
ODP-42150	15	ODP-42200-USA	20	4	69.6	80	25	61	90.5	10	100	6
ODP-42185	18.5	ODP-42250-USA	25	4	76.9	80	25	72	54	10	100	6
ODP-52220	22	ODP-52300-USA	30	5	92.3	100	35	90	67.5	16	100	3
ODP-52300	30	ODP-52400-USA	40	5	116.9	125	50	110	82.5	16	100	3
ODP-52370	37	ODP-52500-USA	50	5	150.2	160	70	150	112.5	25	100	3
ODP-52450	45	ODP-52600-USA	60	5	176.5	200	90	180	135	25	100	3
ODP-62055	55	ODP-62075-USA	75	6	217.2	250	120	202	151.5	35	100	3
ODP-62075	75	ODP-62100-USA	100	6	255.7	315	120	240	180	55	100	3
ODP-62090	90	ODP-62120-USA	120	6	302.4	315	170	300	225	70	100	3

NOTE Values shown in brackets are the maximum for UL applications
For cUL compliance, fuse type Bussmann KTN-R / KTS-R or equivalent must be used

380-480V ±10% - 3 Phase Input drive set for 1 Phase Operation (See section 5.10) 3 Phase Output with Internal RFI Filter

Model	kW	Model	HP	Frame Size	Nominal Input Current	Fuse or MCB (type B)	Supply Cable Size	Nominal Output Current	150% Output Current 60 secs	Motor Cable Size	Max Motor Cable Length	Min Brake Res Value
					Amps	Amps	mm ²	Amps	Amps	mm ²	m	Ω
ODP-24075	0.37	ODP-24010-USA	0.5	2	3.6	6	1	1.1	1.6	1	50	47
ODP-24150	0.75	ODP-24020-USA	0.75	2	6.8	10	1	2	3	1	100	47
ODP-24220	1.1	ODP-24030-USA	1.5	2	9.5	10	1.5	2.9	4.4	1	100	47
ODP-24400	2.2	ODP-24050-USA	3	2	15.5	16	2.5	4.7	7.1	1.5	100	33
ODP-34055	3	ODP-34075-USA	4	3	20.1	25	2.5	7	10.5	1.5	100	22
ODP-34075	4	ODP-34100-USA	5	3	21.6	25	4	9	13.5	1.5	100	22
ODP-34110	5.5	ODP-34150-USA	7.5	3	31.3	40	4	12.5 (12)	18.8 (18)	2.5	100	22
ODP-34150	7.5	ODP-34200-USA	10	3	41.1	50	6	15	22.5	2.5	100	22
ODP-44185	9	ODP-44250-USA	12	4	58.3	63	10	19.5	29.2	4	100	12
ODP-44220	11	ODP-44300-USA	15	4	67.6	80	16	23	34.5	4	100	12
ODP-44300	15	ODP-44400-USA	20	4	87	100	25	30.5	45.8	6	100	12
ODP-44370	18.5	ODP-44500-USA	25	4	96.1	100	25	36	54	10	100	12
ODP-54450	22	ODP-54600-USA	30	5	115.4	125	35	45	67.5	10	100	6
ODP-54550	30	ODP-54750-USA	40	5	146.1	160	50	55	82.5	16	100	6
ODP-54750	37	ODP-54100-USA	50	5	187.8	200	70	75	112.5	16	100	6
ODP-54900	45	ODP-54120-USA	60	5	220.6	250	90	90	135	25	100	6
ODP-64110	55	ODP-64150-USA	75	6	271.5	315	120	101	151.5	35	100	6
ODP-64132	75	ODP-64175-USA	100	6	319.6	400	120	120	180	55	100	6
ODP-64160	90	ODP-64210-USA	120	6	378.0	400	170	150	225	70	100	6

NOTE Values shown in brackets are the maximum for UL applications
For cUL compliance, fuse type Bussmann KTN-R / KTS-R or equivalent must be used
15kW / 20HP rated units not UL listed

380-480V ±10% - 3 Phase Input

3 Phase Output with Internal RFI Filter

Model	kW	Model	HP	Frame Size	Nominal Input Current	Fuse or MCB (type B)	Supply Cable Size	Nominal Output Current	150% Output Current 60 secs	Motor Cable Size	Max Motor Cable Length	Min Brake Res Value
					Amps	Amps	mm ²	Amps	Amps	mm ²	m	Ω
ODP-24075	0.75	ODP-24010-USA	1	2	2.9	6	1	2.2	3.3	1	50	47
ODP-24150	1.5	ODP-24020-USA	2	2	5.4	6	1	4.1	6.2	1	100	47
ODP-24220	2.2	ODP-24030-USA	3	2	7.6	10	1.5	5.8	8.5	1.5	100	47
ODP-24400	4	ODP-24050-USA	5	2	12.4	16	2.5	9.5	14.3	1.5	100	33
ODP-34055	5.5	ODP-34075-USA	7.5	3	16.1	20	2.5	14	21	2.5	100	22
ODP-34075	7.5	ODP-34100-USA	10	3	17.3	20	4	18	27	2.5	100	22
ODP-34110	11	ODP-34150-USA	15	3	25	25	4	25 (24)	37.5 (36)	4	100	22
ODP-34150	15	ODP-34200-USA	20	3	32.9	32	6	30	45	6	100	22
ODP-44185	18.5	ODP-44250-USA	25	4	46.6	50	10	39	58.5	10	100	12
ODP-44220	22	ODP-44300-USA	30	4	54.1	63	16	46	69	10	100	12
ODP-44300	30	ODP-44400-USA	40	4	69.6	80	25	61	91.5	16	100	12
ODP-44370	37	ODP-44500-USA	50	4	76.9	80	25	72	108	16	100	12
ODP-54450	45	ODP-54600-USA	60	5	92.3	100	35	90	135	25	100	6
ODP-54550	55	ODP-54750-USA	75	5	116.9	125	50	110	165	35	100	6
ODP-54750	75	ODP-54100-USA	100	5	150.2	160	70	150	225	55	100	6
ODP-54900	90	ODP-54120-USA	150	5	176.5	200	90	180	270	70	100	6
ODP-64110	110	ODP-64150-USA	160	6	217.2	250	120	202	303	90	100	6
ODP-64132	132	ODP-64175-USA	200	6	255.7	315	120	240	360	120	100	6
ODP-64160	160	ODP-64210-USA	250	6	302.4	315	170	300	450	170	100	6

NOTE

Values shown in brackets are the maximum for UL applications
For cUL compliance, fuse type Bussmann KTN-R / KTS-R or equivalent must be used

480-525V ±10% - 3 Phase Input

3 Phase Output - Unfiltered

Model (kW)	kW	Model (HP)	HP	Frame Size	Nominal Input Current	Fuse or MCB (type B)	Supply Cable Size	Nominal Output Current	150% Output Current 60 secs	Motor Cable Size	Max Motor Cable Length	Min Brake Res Value
					Amps	Amps	mm ²	Amps	Amps	mm ²	m	Ω
ODP-55550	55	N/A	75	5	92.3	100	35	90	135	25	100	6
ODP-55750	75		100	5	116.9	125	50	110	165	35	100	6
ODP-55900	90		120	5	150.2	160	70	150	225	55	100	6
ODP-65132	132		175	6	217.2	250	120	202	303	90	100	6
ODP-65160	160		210	6	255.7	315	120	240	360	120	100	6
ODP-65200	200		250	6	290	315	170	270	405	170	100	6

NOTE

480 – 525 volt rated units are NOT UL listed

500-600V ±10% - 3 Phase Input

3 Phase Output - Unfiltered

Model (kW)	kW	Model (HP)	HP	Frame Size	Nominal Input Current	Fuse or MCB (type B)	Supply Cable Size	Nominal Output Current	150% Output Current 60 secs	Motor Cable Size	Max Motor Cable Length	Min Brake Res Value
					Amps	Amps	mm ²	Amps	Amps	mm ²	m	Ω
ODP-25075	0.75	ODP-25010-USA	1	2	2.2	3	1	1.7	2.6	1	50	47
ODP-25150	1.5	ODP-25020-USA	2	2	4.1	6	1	3.1	4.7	1	100	47
ODP-25220	2.2	ODP-25030-USA	3	2	5.4	6	1	4.1	6.2	1	100	47
ODP-25370	3.7	ODP-25050-USA	5	2	7.6	10	1.5	6.1	9.2	1.5	100	47
ODP-25550	5.5	ODP-25075-USA	7.5	2	11.7	16	2.5	9	13.5	2.5	100	47
ODP-35075	7.5	ODP-35100-USA	10	3	16.1	20	2.5	14	21	2.5	100	22
ODP-35110	11	ODP-35150-USA	15	3	17.3	20	4	18	27	2.5	100	22
ODP-35150	15	ODP-35200-USA	20	3	24.1	25	4	24	36	4	100	22
ODP-45220	22	ODP-45300-USA	30	4	46.6	63	10	39	58.5	10	100	12
ODP-45300	30	ODP-45400-USA	40	4	54.1	63	16	46	69	10	100	12
ODP-45450	45	ODP-45600-USA	60	4	69.6	80	25	62	93	16	100	12

NOTE

For cUL compliance, fuse type Bussmann KTN-R / KTS-R or equivalent must be used
An external input choke must be fitted for all Frame Size 2 units

9.3. Maximum supply ratings for UL compliance:

Drive rating		Maximum supply voltage	Maximum supply short-circuit current
230V ratings	0.37kW (0.5HP) to 18.5kW (25HP)	240V rms (AC)	5kA rms (AC)
230V ratings	22kW (30HP) to 90kW (120HP)	240V rms (AC)	10kA rms (AC)
400/460V/600V ratings	0.75kW (1.0HP) to 37kW (50HP)	500V/600V rms (AC)	5kA rms (AC)
400/460V/600V ratings	45kW (60HP) to 132kW (175HP)	500V/600V rms (AC)	10kA rms (AC)
400/460V/600V ratings	160kW (210HP)	500V/600V rms (AC)	18kA rms (AC)

All the drives in the above table are suitable for use on a circuit capable of delivering not more than the above specified maximum short-circuit Amperes symmetrical with the specified maximum supply voltage.

9.4. Recommended Maintenance

Under normal operating conditions, Optidrive Plus are maintenance free, however regular inspection and maintenance will ensure the best possible service life is obtained. The list below provides some recommendations for Optidrive Plus installed in a typical control room environment. Installations which are subject to high ambient temperatures or other conditions may require additional and more frequent maintenance.

- Check the drive heatsink and cooling channels are clean and free from dust on a regular basis – at least every 6 months. Dusty environments will require more frequent inspection.
- For panel mounted drives, regularly check and replace any cooling fans and filters fitted to the panel.
- After 3 years / 20,000 hours operation, the Optidrive Plus' internal heatsink cooling fans (where fitted) should be regularly monitored to ensure they are fully operational.
- After 3 – 5 years / 40,000 hours operation, replace the Optidrive Plus cooling fans.
- Control Panel fans should be replaced based on the manufacturer's recommendation.

10. Modbus Communications

10.1. Introduction

The Optidrive Plus 3^{GV} can be connected to a Modbus RTU network via the RJ11 connector on the front of the drive.

10.2. Modbus RTU Specification

Protocol	Modbus RTU
Error check	CRC
Baud rate	9600bps, 19200bps, 38400bps, 57600bps, 115200bps (default)
Data format	1 start bit, 8 data bits, 1 stop bits, no parity.
Physical signal	RS 485 (2-wire)
User interface	RJ11 (see section 4.4 for more information)

10.3. RJ11 Connector Configuration

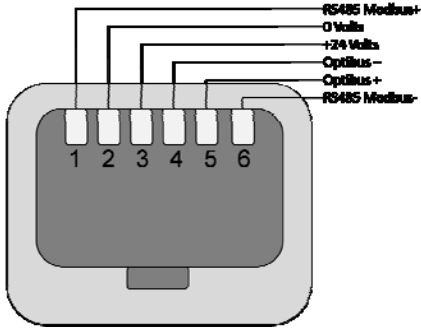

10.4. Modbus Telegram Structure

The Optidrive Plus 3^{GV} supports Master / Slave Modbus RTU communications, using the 03 Read Holding Registers and 06 Write Single Holding Register commands. Many Master devices treat the first Register address as Register 0, therefore it may be necessary to convert the Register Numbers detail in section 0 by subtracting 1 to obtain the correct Register address. The telegram structure is as follows:-

Command 03 – Read Holding Registers					
Master Telegram			Slave Response		
	Length			Length	
Slave Address	1	Byte	Slave Address	1	Byte
Function Code (03)	1	Byte	Starting Address	1	Byte
1 st Register Address	2	Bytes	1 st Register Value	2	Bytes
No. Of Registers	2	Bytes	2 nd Register Value	2	Bytes
CRC Checksum	2	Bytes	Etc...		
			CRC Checksum	2	Bytes

Command 06 – Write Single Holding Register					
Master Telegram			Slave Response		
	Length			Length	
Slave Address	1	Byte	Slave Address	1	Byte
Function Code (06)	1	Byte	Function Code (06)	1	Byte
Register Address	2	Bytes	Register Address	2	Bytes
Value	2	Bytes	Register Value	2	Bytes
CRC Checksum	2	Bytes	CRC Checksum	2	Bytes

10.5. Modbus Register Map

Register Number	Par.	Type	Supported Commands	Function		Range	Explanation
				Low Byte	High Byte		
1	-	R/W	03,06	Drive Control Command		0..3	16 Bit Word. Bit 0 : Low = Stop, High = Run Enable Bit 1 : Low = No Function, High = Fault Reset Bit 2 : Low = Decel Ramp 1 (P1-04), High = Decel Ramp 2
2	-	R/W	03,06	Modbus Speed reference setpoint		0..20000	Setpoint frequency x10, e.g. 100 = 10.0Hz
3	-	R/W	03,06	Torque reference		0..2000	Torque Setpoint %x10, e.g. 1000 = 100.0%
4	-	R/W	03,06	Acceleration and Deceleration Time		0..255	Ramp time in seconds x 10, e.g. 250 = 25 seconds
5	-	R	03	Reserved			
6	-	R	03	Error code	Drive status		Low Byte = Drive Error Code, see table below High Byte = Drive Status as follows :- 0 : Drive Stopped 1: Drive Running 2: Drive Tripped
7		R	03	Output Motor Frequency		0..20000	Output frequency in Hz x10, e.g. 100 = 10.0Hz
8		R	03	Output Motor Current		0..6000	Output Motor Current in Amps x10, e.g. 10 = 1.0 Amps
9	P0-13	R	03	Output Motor Torque		0..2000	Output Motor Torque %x10, e.g. 1000 = 100.0%
10		R	03	Output Motor Power		0..3200	Output Motor Power in kW x10, e.g. 100 = 10.0kW
11	-	R	03	Digital input status		0..15	Indicates the status of the 4 digital inputs Lowest Bit = 1 Input 1
21	P0-01	R	03	Bipolar analog input value		0..1000	Analog input % of full scale x10, e.g. 1000 = 100%
22	P0-02	R	03	2 nd analog input value		0..1000	Analog input % of full scale x10, e.g. 1000 = 100%
40	P0-20	R	03	DC bus voltage		0..1000	DC Bus Voltage in Volts
41	P0-21	R	03	Drive temperature		0..100	Drive heatsink temperature in °C
42	P0-22	R	03	Supply voltage L1		0..660	L1 – L2 Supply Voltage
43	P0-23	R	03	Supply voltage L2		0..660	L2 – L3 Supply Voltage
44	P0-24	R	03	Supply voltage L3		0..660	L3 – L1 Supply Voltage
45	P0-25	R	03	Estimated rotor speed			Internal Speed Value
46	P0-26	R	03	kWh meter		0..1000	Energy consumed in kWh
47	P0-27	R	03	MWh meter		0..65535	Energy consumed in MWh

Further registers are available; see the Optidrive Plus 3^{GV} Advanced User Guide for details.

11. IP55 Enclosed Drive

11.1. Overview

Optidrive Plus 3GV is optionally available in an IP55 enclosed version for power ratings up to 4kW / 5HP. Un-switched versions have no built in controls. Switched versions have built in local isolator, Potentiometer and control switch.

11.2. Models and Ratings

200-240V ±10% - 1 Phase Input – 3 Phase Output						
Model (kW)	kW	Model (HP)	HP	Frame Size	Nominal Input Current	Nominal Output Current
					Amps	Amps
ODP-12037-xx-I55	0.37	ODP-12005-USA-I55	0.5	1	6.7	2.3
ODP-12075-xx-I55	0.75	ODP-12010-USA-I55	1	1	12.5	4.3
ODP-12150-xx-I55	1.5	ODP-12020-USA-I55	2	1	19.3	7
ODP-22150-xx-I55	1.5	ODP-22020-USA-I55	2	2	19.3	7
ODP-22220-xx-I55	2.2	ODP-22030-USA-I55	3	2	28.8	10.5

200-240V ±10% - 3 Phase Input – 3 Phase Output						
Model	kW	Model	HP	Frame Size	Nominal Input Current	Nominal Output Current
					Amps	Amps
ODP3-22150-xx-I55	1.5	ODP3-22020-USA-I55	2	2	9.2	7
ODP3-22220-xx-I55	2.2	ODP-22030-USA-I55	3	2	13.7	10.5 (9)

380-480V ±10% - 3 Phase Input – 3 Phase Output						
Model	kW	Model	HP	Frame Size	Nominal Input Current	Nominal Output Current
					Amps	Amps
ODP-24075-xx-I55	0.75	ODP-24010-USA-I55	1	2	2.9	2.2
ODP-24150-xx-I55	1.5	ODP24020-USA-I55	2	2	5.4	4.1
ODP-24220-xx-I55	2.2	ODP-24030-USA-I55	3	2	7.6	5.8
ODP-24400-xx-I55	4	ODP-24050-USA-I55	5	2	12.4	9.5

500-600V ±10% - 3 Phase Input – 3 Phase Output						
Model (kW)	kW	Model (HP)	HP	Frame Size	Nominal Input Current	Nominal Output Current
					Amps	Amps
ODP-25075-xx-I55	0.75	ODP-25010-USA-I55	1	2	2.2	1.7
ODP-25150-xx-I55	1.5	ODP-25020-USA-I55	2	2	4.1	3.1
ODP-25220-xx-I55	2.2	ODP-25030-USA-I55	3	2	5.4	4.1
ODP-25370-xx-I55	3.7	ODP-25050-USA-I55	5	2	7.6	6.1
ODP-25550-xx-I55	5.5	ODP-25075-USA-I55	7.5	2	11.7	9

NOTE

For switched versions, an 'S' is added to the end of the part number, E.g. ODP12037-I55S
 All other rating data is as per IP20 units, see table on page 27
 xx = Country Specific Model Code

11.3. Power and Motor Cable Installation

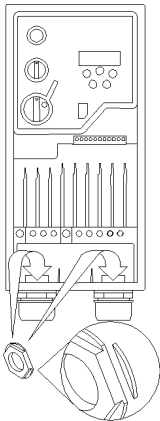
	Some types of gland nut will require modification for correct installation. Remove one or more flanges as shown until the nut will fit in the apertures. Any Metal conduit used MUST be earth bonded by means of suitable earthing washer or gland adaptor. Lock Off: On the switched models the main power isolator switch can be locked in the 'Off' position using a 20mm standard shackle padlock (not supplied).			
	Gland Hole Sizes:			
		I/P & O/P Power (Φ)	Centre Knockout (Φ)	Terminal Cover Knockout (Φ)
	Size 1	(22mm)	(22mm)	(17mm)
	Size 2	(25mm)	(22mm)	(17mm)
Recommended Gland Type: SkinTop UL approved (UL94-V0) Type12/IP55 non-metallic cable gland or non-rigid conduit				
	I/P & O/P Power	Centre Knockout	Terminal Cover Knockout	
Size 1	PG13.5 / M20	PG13.5 / M20	PG9 / M16	
Size 2	PG16 / M25	PG13.5 / M20	PG9 / M16	

11.4. Dimensions and Mounting

Optidrive Plus IP55 Size 1 Layout, Dimensions and Mounting



- Height 200mm
- Width 140mm
- Depth 162mm
- Weight 2.3Kg
- Display
- Keypad
- IR Interface
- Control Terminals
- Power Input Terminals
- Motor Output Terminals



Footprint View

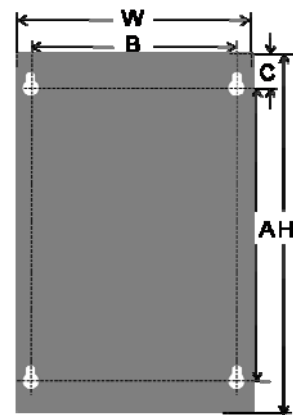

- Height 200mm
- Width 140mm
- Depth 162mm
- A 141.5mm
- B 127.5mm
- C 25mm

Fixings : 4 x M4 Keyhole slots

Optidrive Plus IP55 Size 2 Layout, Dimensions and Mounting



- Height 310mm
- Width 165mm
- Depth 176mm
- Weight 4.5Kg
- Display
- Keypad
- IR Interface
- Control Terminals
- Power Input Terminals
- Motor Output Terminals



Footprint View

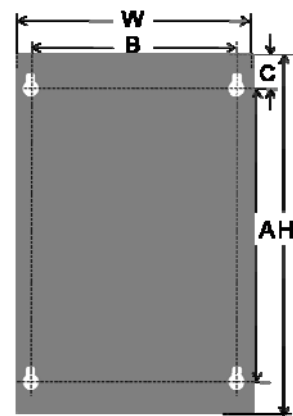

- Height 310mm
- Width 165mm
- Depth 176mm
- A 251.5mm
- B 153mm
- C 25mm

Fixings : 4 x M4 Keyhole slots

11.5. Removing the Terminal Cover

To access the connection terminals, the drive front cover needs to be removed as shown below.

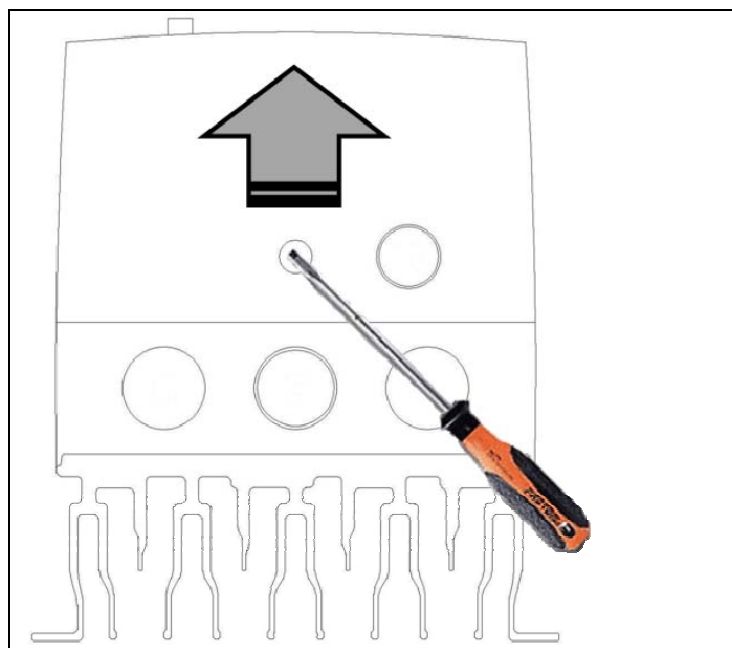

11.6. Control Terminal Wiring – None Switched Version

Wiring configuration and terminal connections for the none switched IP55 version are identical to those of the IP20 version, as shown in section 4.7 on page 11.

11.7. IP55 / Nema 12K Switched Version - Wiring diagram for in-built switches

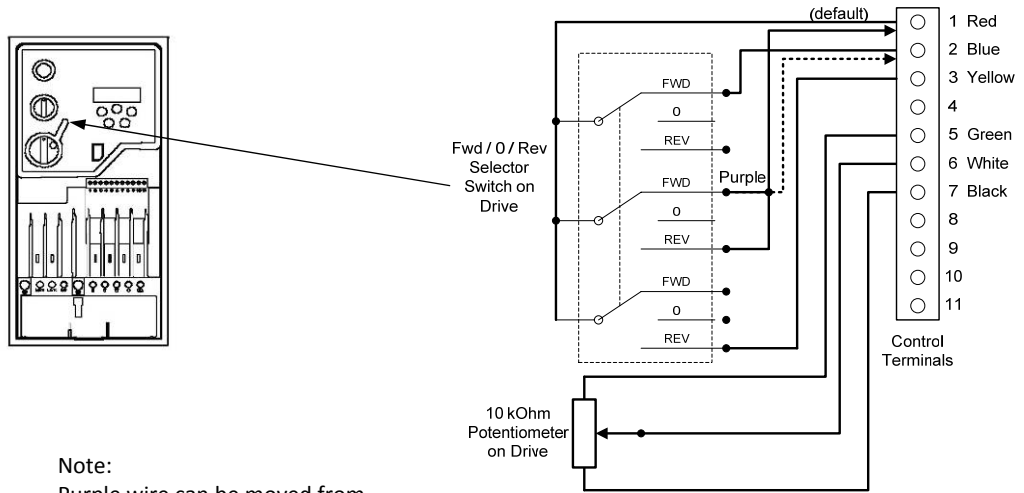

Note:
Purple wire can be moved from terminal 1 (default) to terminal 2 to give greater functionality - see table below.

11.8. Settings for typical Run / Stop switch configurations (Switched Version)

The table below shows the possible configurations that can be achieved by connecting the Purple wire to the designated terminal, and setting a combination of P1-12 and P2-01. Unless otherwise stated, each of the following configurations utilise the potentiometer mounted on the front of the IP55S drive (switched variant) for speed variation and control.

Purple Wire in Terminal	Switch Position			P1-12	P2-01	Notes
1	Stop	Stop	Run Forward	0	0	Factory Default Configuration
2	Preset Speed 1	Stop	Run Forward	0	0	Preset Speed 1 provides a 'Jog' Speed
1	Run Reverse	Stop	Run Forward	0	7, 8, 9, 10	
2	Run in Speed Control	Stop	Run in PID Control	3	17	In Speed Control, Pot controls speed In PID Control, pot controls setpoint
2	Run in Speed Control	Stop	Run in PID Control	3	11	In Speed Control, P1-11 sets the Preset Speed In PID Control, pot controls setpoint
2	Run in Hand	Stop	Run in Auto	4	17	Hand – Speed reference from Pot Auto – Speed Reference from Modbus
2	Run in Hand	Stop	Run in Auto	4	17	Hand – Speed reference from Preset Speed 1 Auto – Speed Reference from Modbus

OPTIDRIVE PLUS EASY START-UP GUIDE

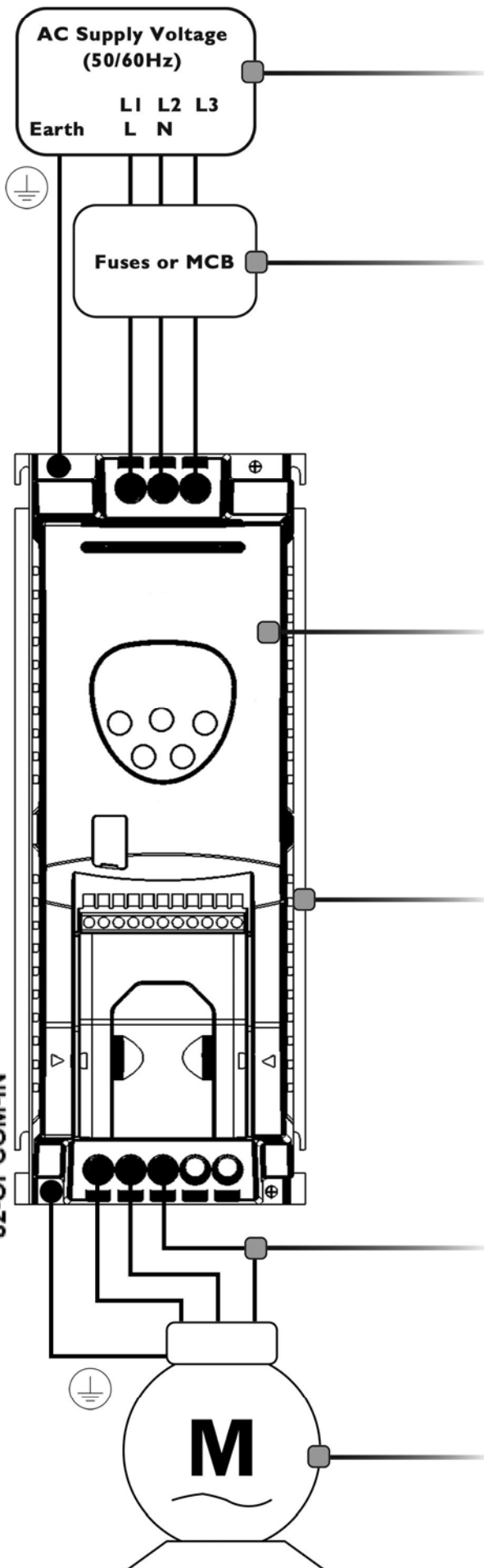

Supply Voltage

- 200 – 240 Volt + / - 10%, 1 or 3 Phase
- 380 – 480 Volts + / - 10%, 1 or 3 Phase
- 480 – 525 Volts + / - 10%, 3 Phase
- 500 – 600 Volts + / - 10%

See Page 5

Fuses or MCB & Cable Sizes

- Check drive rating information on page 27

Keypad operation – see page 14

Control Terminal Wiring – based on default settings :-

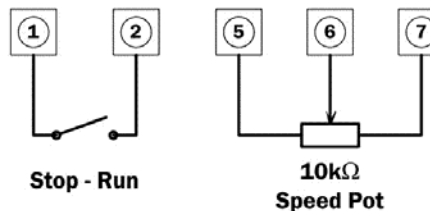

Motor Cable Sizes

- Check drive rating information on page 27

Motor Connections

- Check for Star or Delta (see page 10)

Motor Nameplate Details

- Enter the motor rated voltage(V) in P1-07
- Enter the motor rated current (A) in P1-08
- Enter the motor rated frequency (Hz) in P1-09